

Specification

DV215FHM-R01

21,5" - 1920 x 1080 – LVDS

Spec Revision: P.A
Revision Date: 20.08.2023

Note: This specification is subject to change without prior notice

PROPRIETARY NOTE

THIS SPECIFICATION IS THE PROPERTY OF BOE HF AND SHALL NOT BE REPRODUCED OR COPIED WITHOUT THE WRITTEN PERMISSION OF BOE HF AND MUST BE RETURNED TO BOE HF UPON ITS REQUEST



SPEC. NUMBER	PRODUCT GROUP TFT- LCD	REV. P0	ISSUE DATE 2023.08.20	PAGE 1 OF 30
--------------	---------------------------	------------	--------------------------	-----------------

DV215FHM-R01 Product Specification Rev. A

SUPPLIER	BEIJING BOE Display TECHNOLOGY CO., LTD
FG-Code	DV215FHM-R01

ITEM	BUYER SIGNATURE	DATE
_____	_____	_____
_____	_____	_____
_____	_____	_____

ITEM	SUPPLIER SIGNATURE	DATE
Prepared	_____	_____
Reviewed	_____	_____
Approved	_____	_____

REVISION HISTORY

REV.	ECN NO.	DESCRIPTION OF CHANGES	DATE	PREPARED
0	-	Initial Release	2023.07.03	Zhu YuanChao
A	-	Final Release	2023.08.20	Zhu YuanChao

Contents

No.	Items	Page
1.0	General Description	4
2.0	Absolute Maximum ratings	6
3.0	Electrical specifications.	7
4.0	Interface Connection	9
5.0	Signal Timing Specifications	11
6.0	Power Sequence	12
7.0	Optical specifications.	13
8.0	Mechanical Characteristics	17
9.0	Reliability Test	18
10.0	Precautions	19
11.0	Label	23
12.0	Packing information	25
13.0	Mechanical Outline Dimension	26

1.0 GENERAL DESCRIPTION

1.0.1 Introduction

DV215FHM-R01 is a color active matrix TFT LCD module using amorphous silicon TFT's (Thin Film Transistors) as an active switching devices. This module has a 21.5 inch diagonally measured active area with FHD resolutions (1920 horizontal by 1080 vertical pixel array). Each pixel is divided into RED, GREEN, BLUE dots which are arranged in vertical stripe and this module can display 16.7M colors.

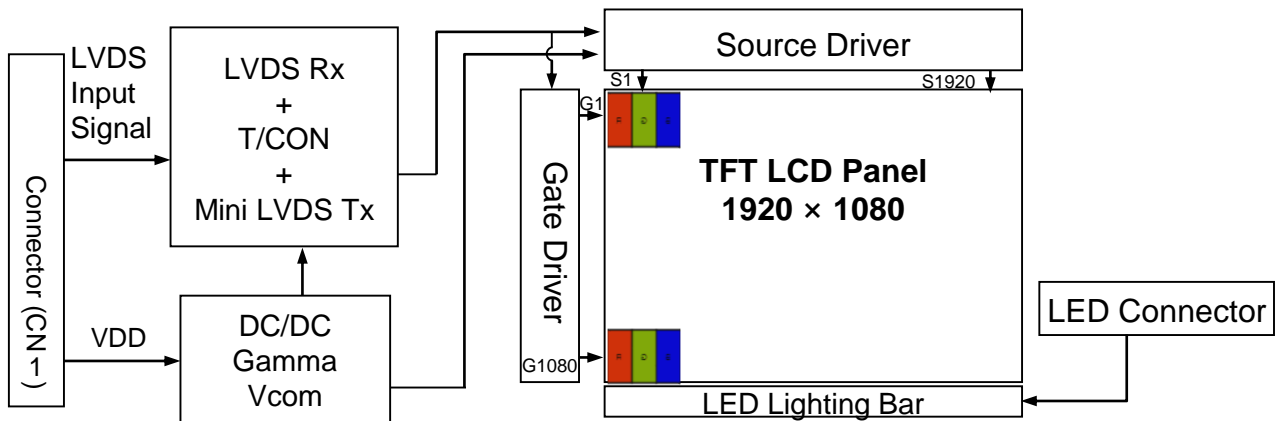

1.0.2 Features

- LVDS Interface with 2 pixel / clock
- High-speed response
- 0.5t Glass
- 6-bit (Hi-FRC) color depth, display 16.7M colors
- Incorporated edge type back-light (One Light Bar)
- High luminance and contrast ratio, low reflection and wide viewing angle
- DE (Data Enable) only
- RoHS/Halogen Free
- Gamma Correction
- Landscape and Portrait Display
- High TNI 105°C

1.0.3 Application

- Desktop Type of PC & Workstation Use
- Slim-Size Display for Stand-alone Monitor
- Display Terminals for Control System
- Monitors for Process Controller
- Digital Signage for Class Information
- Storage Cabinet for Outdoor

1.0.4 General Specification

The followings are general specifications at the model DV215FHM-R01

<Table 1. General Specifications>

Parameter	Specification	Unit	Remarks
Active area	476.64(H) × 268.11(V)	mm	
Number of pixels	1920(H) × 1080(V)	pixels	
Pixel pitch	0.24825(H) x 0.24825(V)	mm	
Pixel arrangement	RGB Vertical stripe	-	
Display colors	16.7M	colors	
Display mode	Normally Black	-	
Dimensional outline	495.6(H) × 292.2(V) × 10.7(D) typ.	mm	Detail refer to drawing
Possible Display Type	Landscape and Portrait Enabled	-	
Weight	1.93	Kg	
Bezel width (L/R/U/D)	7.9/7.9/10.5/10.5	mm	
Surface Treatment	Haze 25%, 3H	-	
Back-light	Lower side 1-LED Light bar Type	-	
temperature	operating	-20~85	°C High TNI 105°C
	storage	-30~85	

2.0 ABSOLUTE MAXIMUM RATINGS

The followings are maximum values which, if exceed, may cause faulty operation or damage to the unit. The operational and non-operational maximum voltage and current values are listed in Table 2.

< Table 2. Absolute Maximum Ratings >

[VSS=GND=0V]

Parameter	Symbol	Min.	Max.	Unit	Remarks
Power Supply Voltage	V_{DD}	-0.3	5.5	V	Ta = 25 °C
Logic Supply Voltage	V_{IN}	VSS-0.3	$V_{DD}+0.3$	V	
Operating Temperature	T_{OP}	-20	+85	°C	
Storage Temperature	T_{ST}	-30	+85	°C	
Liquid crystal clear point	T_{Lc}	104.9		°C	Typ.

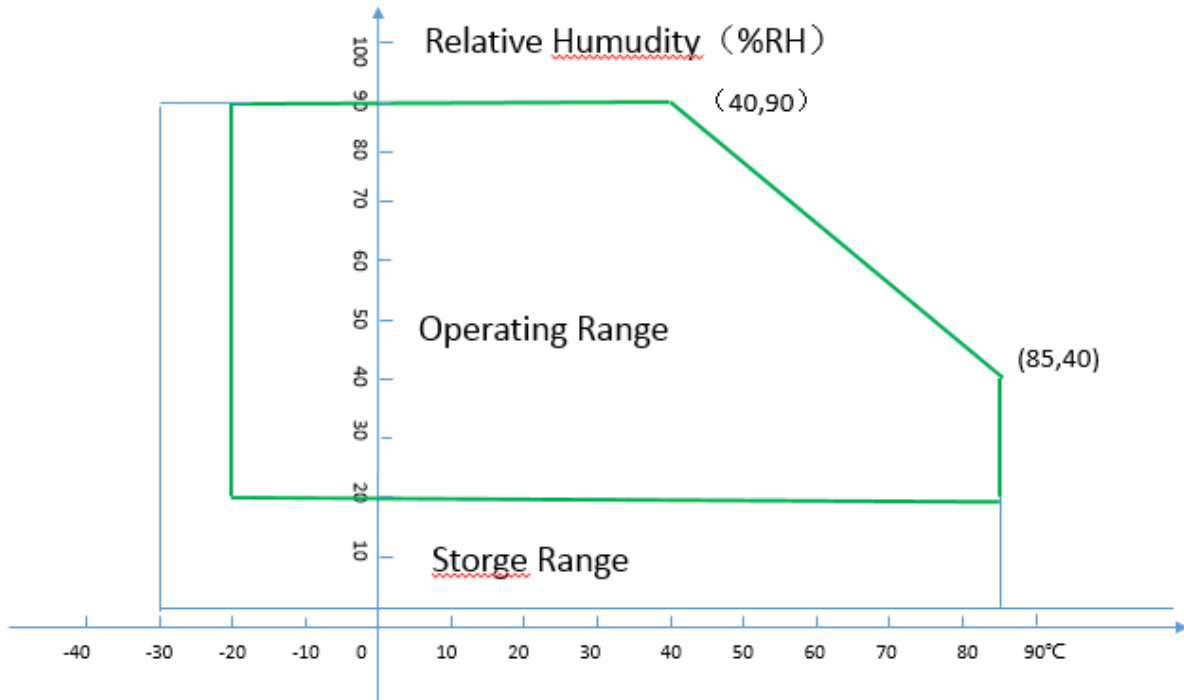

3.0 ELECTRICAL SPECIFICATIONS

3.0.1 Electrical Specifications

< Table 3. Electrical specifications >

[Ta =25±2 °C]

Parameter		Min.	Typ.	Max.	Unit	Remarks
Power Supply Voltage	V _{DD}	4.5	5.0	5.5	V	Note 1
Power Supply Current	I _{DD}	-	700	1200	mA	
In-Rush Current	I _{RUSH}	-	-	3	A	Note 2
Permissible Input Ripple Voltage	V _{RF}	-	-	300	mV	V_{DD} = 5.0V
High Level Differential Input Threshold Voltage	V _{IH}	-	-	+100	mV	
Low Level Differential Input Threshold Voltage	V _{IL}	-100	-	-	mV	
Differential input voltage	V _{ID}	100	-	400	mV	
Differential input common mode voltage	V _{cm}	0.7	-	1.6		V _{IH} =100mV, V _{IL} =-100mV
LED Voltage	V _L	-	3.0	3.3	V	
LED Channel Voltage	V _L	-	51	56.1	V	Duty 100%
LED Channel Current	I _L		90		mA	Duty 100%, Each channel
LED Lifetime		30000	-	-	Hrs	I _L =90 mA, Note 4
Power Consumption	P _D	-	3.5	5.4	W	
	P _{BL}	-	18.36	20.2	W	I _L =90mA, Note 3
	P _{total}	-	21.86	25.6	W	

Notes : 1. The supply voltage is measured and specified at the interface connector of LCM.

The current draw and power consumption specified is for VDD=5.0V, Frame rate=60Hz. Test Pattern of power supply current

a) Typ : Color Bar pattern

b) Max : Gray Level 255 Pattern

2. Duration of rush current is about 2 ms and rising time of VDD is 520 μs ± 20 %

3. Calculated value for reference (V_L × I_L) ×4(channel) excluding driver loss. (LED Light bar: 17S4P)

4. The lifetime is determined as the time at which luminance of LED become 50% of the initial brightness or not normal lighting at IPIN=90mA on condition of continuous operating at 25 ±2 °C

4.0 INTERFACE CONNECTION.

4.0.1 Electrical Interface Connection

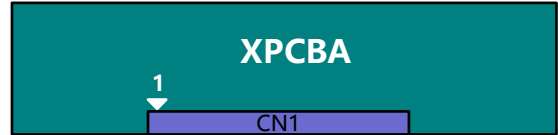

- CN1 Module Side Connector : UJU IS100-L300-C23 or MSBKT2407P30
 User Side Connector : JAE FI-X30H

Pin No	Symbol	Function	Remark
1	RXO0-	Negative Transmission data of Pixel 0 (ODD)	
2	RXO0+	Positive Transmission data of Pixel 0 (ODD)	
3	RXO1-	Negative Transmission data of Pixel 1 (ODD)	
4	RXO1+	Positive Transmission data of Pixel 1 (ODD)	
5	RXO2-	Negative Transmission data of Pixel 2 (ODD)	
6	RXO2+	Positive Transmission data of Pixel 2 (ODD)	
7	GND	Power Ground	
8	RXOC-	Negative Transmission Clock (ODD)	
9	RXOC+	Positive Transmission Clock (ODD)	
10	RXO3-	Negative Transmission data of Pixel 3 (ODD)	
11	RXO3+	Positive Transmission data of Pixel 3 (ODD)	
12	RXE0-	Negative Transmission data of Pixel 0 (EVEN)	
13	RXE0+	Positive Transmission data of Pixel 0 (EVEN)	
14	GND	Power Ground	
15	RXE1-	Negative Transmission data of Pixel 1 (EVEN)	
16	RXE1+	Positive Transmission data of Pixel 1 (EVEN)	
17	GND	Power Ground	
18	RXE2-	Negative Transmission data of Pixel 2 (EVEN)	
19	RXE2+	Positive Transmission data of Pixel 2 (EVEN)	
20	RXEC-	Negative Transmission Clock (EVEN)	
21	RXEC+	Positive Transmission Clock (EVEN)	
22	RXE3-	Negative Transmission data of Pixel 3 (EVEN)	
23	RXE3+	Positive Transmission data of Pixel 3 (EVEN)	
24	GND	Power Ground	Note 1
25	NC	Not connection, this pin should be open	
26	NC	Not connection, this pin should be open	
27	NC	Not connection	
28	VDD	Power Supply: +5V	
29	VDD		
30	VDD		

Note 1 : This pin should be connected with GND.

4.0.2 Data Input Format

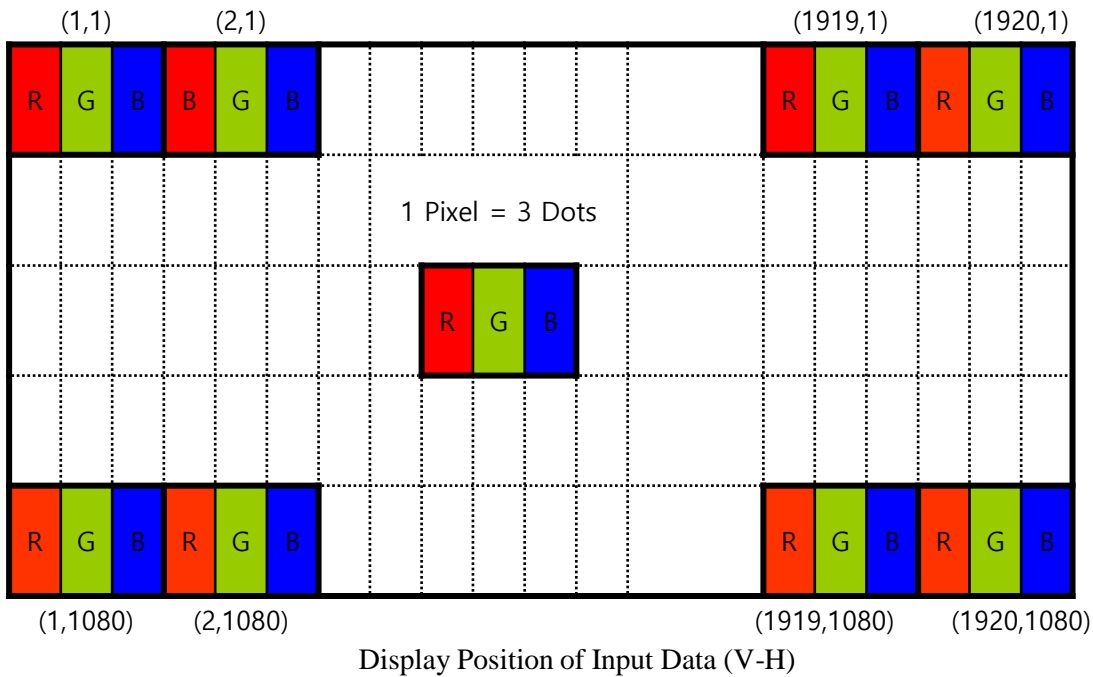

4.0.3 Back-light Interface Connection

-LED connector : 3707K-Q06N-08X manufactured by Entry

Pin No	Symbol	Description
1	IRLED1	LED current sense for string1
2	IRLED2	LED current sense for string2
3	VLED	LED power supply
4	VLED	LED power supply
5	IRLED3	LED current sense for string3
6	IRLED4	LED current sense for string4

5.0 SIGNAL TIMING SPECIFICATION

5.0.1 The DV215FHM-R01 is operated by the DE only.

Item		Symbols	Min	Typ	Max	Unit
Clock	Frequency	1/Tc	63	74.25	88	MHz
	High Time	-	-	4/7Tc	-	
	Low Time	-	-	3/7Tc	-	
Frame Period		Tv	1100	1125	1200	line
			55	60	65	Hz
			15.38	16.67	18.18	ms
Vertical Display Period		Tvd	-	1080	-	line
One line Scanning Period		Th	1050	1100	1120	clocks
Horizontal Display Period		Thd	-	960	-	clocks

5.0.2 LVDS Rx Interface Timing Parameter

The specification of the LVDS Rx interface timing parameter is shown in Table 4.

<Table 4. LVDS Rx Interface Timing Specification>

Item	Symbol	Min	Typ	Max	Unit	Remark
CLKIN Period	tRCIP	10.76	13.46	16.15	nsec	
Input Data 0	tRIP1	-0.4	0.0	+0.4	nsec	
Input Data 1	tRIP0	tRCIP/7-0.4	tRCIP/7	tRCIP/7+0.4	nsec	
Input Data 2	tRIP6	2 × tRCIP/7-0.4	2 × tRCIP/7	2 × tRCIP/7+0.4	nsec	
Input Data 3	tRIP5	3 × tRCIP/7-0.4	3 × tRCIP/7	3 × tRCIP/7+0.4	nsec	
Input Data 4	tRIP4	4 × tRCIP/7-0.4	4 × tRCIP/7	4 × tRCIP/7+0.4	nsec	
Input Data 5	tRIP3	5 × tRCIP/7-0.4	5 × tRCIP/7	5 × tRCIP/7+0.4	nsec	
Input Data 6	tRIP2	6 × tRCIP/7-0.4	6 × tRCIP/7	6 × tRCIP/7+0.4	nsec	

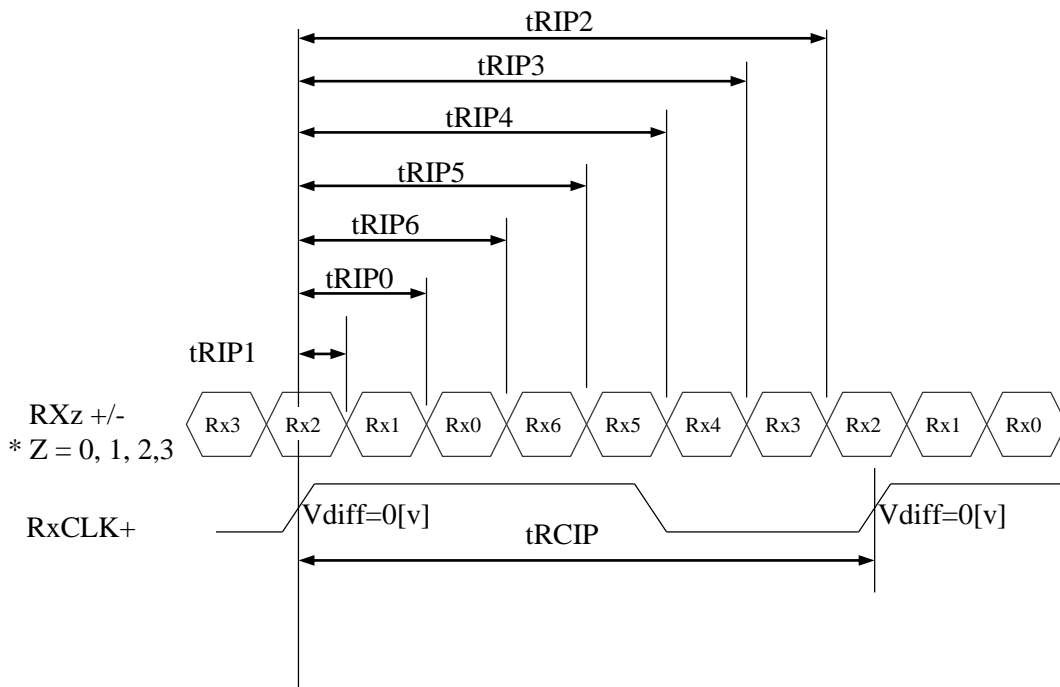

* Vdiff = (RXz+)-(RXz-),..., (RXCLK+)-(RXCLK-)

6.0 POWER SEQUENCE

To prevent a latch-up or DC operation of the LCD module, the power on/off sequence shall be as shown in below

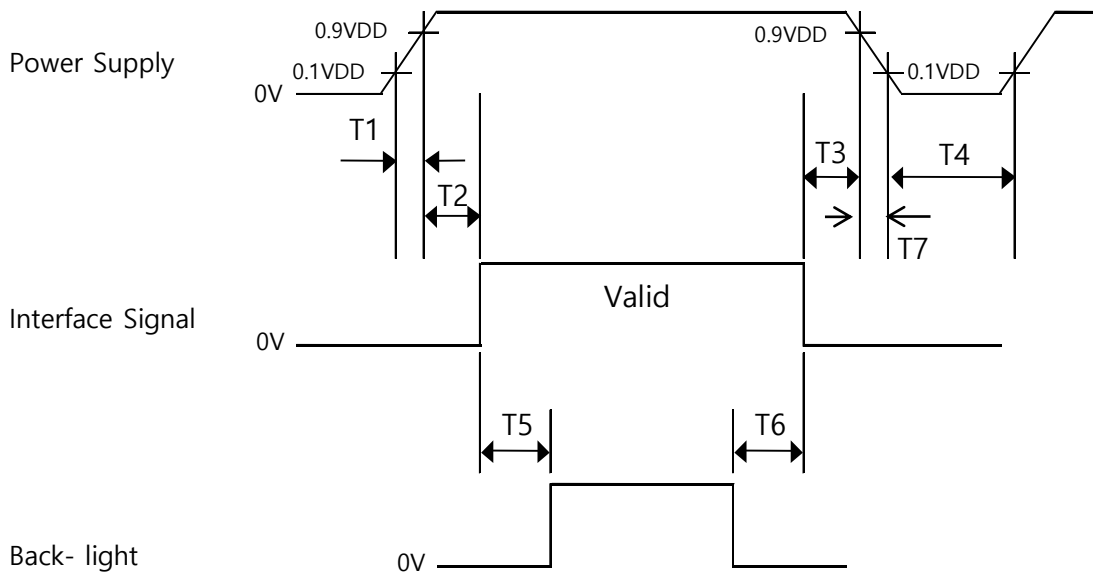

- $0.5 \text{ ms} \leq T1 \leq 10 \text{ ms}$
- $0 \leq T2 \leq 50 \text{ ms}$
- $0 \leq T3 \leq 50 \text{ ms}$
- $1 \text{ sec} \leq T4$
- $200 \text{ ms} \leq T5$
- $200 \text{ ms} \leq T6$

Notes:

1. When the power supply VDD is 0V, keep the level of input signals on the low or keep high impedance.
2. Do not keep the interface signal high impedance when power is on.
3. Back Light must be turn on after power for logic and interface signal are valid.
4. T7 decreases smoothly, there is none re-bouncing voltage.
5. During changing the resolution or mode changing, the logic power/ back-light/interface signal should be turned off as shown above; after the changing, power on as shown above.

7.0 OPTICAL SPECIFICATION

7.0.1 Overview

The test of Optical specifications shall be measured in a dark room (ambient luminance ≤ 1 lux and temperature = $25 \pm 2^\circ\text{C}$) with the equipment of Luminance meter system (Goniometer system and TOPCONE PR730) and test unit shall be located at an approximate distance 50cm from the LCD surface at a viewing angle of θ and Φ equal to 0° . We refer to $\theta_{\Phi=0}$ ($=\theta_3$) as the 3 o'clock direction (the "right"), $\theta_{\Phi=90}$ ($=\theta_{12}$) as the 12 o'clock direction ("upward"), $\theta_{\Phi=180}$ ($=\theta_9$) as the 9 o'clock direction ("left") and $\theta_{\Phi=270}$ ($=\theta_6$) as the 6 o'clock direction ("bottom"). While scanning θ and/or Φ , the center of the measuring spot on the Display surface shall stay fixed. The measurement shall be executed after 30 minutes warm-up period. VDD shall be 5.0V +/-10% at 25°C . Optimum viewing angle direction is 6 'clock.

7.0.2 Optical Specifications

[VDD = 5.0V, Frame rate = 60Hz, Clock = 74.25MHz, $I_{BL} = 408\text{mA}$, $T_a = 25 \pm 2^\circ\text{C}$]

< Table 5. Module Optical >

Parameter	Symbol	Condition	Min.	Typ.	Max.	Unit	Remark	
Viewing Angle range	Horizontal	Θ_3	85	89	-	Deg.	Note 1	
		Θ_9	85	89	-	Deg.		
	Vertical	Θ_{12}	85	89	-	Deg.		
		Θ_6	85	89	-	Deg.		
Luminance Contrast ratio	CR	$\Theta = 0^\circ$ (Center) Normal Viewing Angle	700	1000			Note 2	
Luminance of White	Y_w		280	350	-	cd/m ²	Note 3	
Colour gamut			68%	72%	-		NTSC	
White luminance uniformity	ΔY		75	80	-	%	Note 4	
Reproduction of color	White		W_x	0.283	0.313	0.343	-	Note 5
			W_y	0.299	0.329	0.359	-	
	Red		R_x	0.609	0.639	0.669	-	
			R_y	0.319	0.349	0.379	-	
	Green		G_x	0.267	0.297	0.327	-	
			G_y	0.586	0.616	0.646	-	
	Blue	B_x	0.119	0.149	0.179	-		
		B_y	0.020	0.050	0.070	-		
Response Time	GTG	T_g		14	25	ms	Note 6	
Cross Talk	CT		-	-	2.0	%	Note 7	

Note :

- Viewing angle is the angle at which the contrast ratio is greater than 10. The viewing are determined for the horizontal or 3, 9 o'clock direction and the vertical or 6, 12 o'clock direction with respect to the optical axis which is normal to the LCD surface.
- Contrast measurements shall be made at viewing angle of $\theta=0^\circ$ and at the center of the LCD surface. Luminance shall be measured with all pixels in the view field set first to white, then to the dark (black) state. (See FIGURE 1 shown in Appendix) Luminance Contrast Ratio (CR) is defined mathematically.

$$CR = \frac{\text{Luminance when displaying a white raster}}{\text{Luminance when displaying a black raster}}$$

- Center Luminance of white is defined as the LCD surface. Luminance shall be measured with all pixels in the view field set first to white. This measurement shall be taken at the locations shown in FIGURE 2 for a total of the measurements per display.
- The White luminance uniformity on LCD surface is then expressed as :
 $\Delta Y = (\text{Minimum Luminance of 9points} / \text{Maximum Luminance of 9points}) * 100$
 (See FIGURE 2 shown in Appendix).
- The color chromaticity coordinates specified in Table 5. shall be calculated from the spectral data measured with all pixels first in red, green, blue and white. Measurements shall be made at the center of the panel.
- Response time T_g is the average time required for display transition by switching the input signal as below table and is based on Frame rate $f_V = 60\text{Hz}$ to optimize. Each time in below table is defined as appendix Figure 3 and shall be measured by switching the input signal for "any level of gray(bright)" and "any level of gray(dark)".

Measured Response Time	Target																
	0	15	31	47	63	79	95	111	127	143	159	175	191	207	223	239	255
0																	
15																	
31																	
47																	
63																	
79																	
95																	
111																	
127																	
143																	
159																	
175																	
191																	
207																	
223																	
239																	
255																	

- Cross-Talk of one area of the LCD surface by another shall be measured by comparing the luminance (Y_A) of a 25mm diameter area, with all display pixels set to a gray level, to the luminance (Y_B) of that same area when any adjacent area is driven dark. (See FIGURE 4 shown in Appendix).

7.0.3 Optical measurements

Figure 1. Measurement Set Up

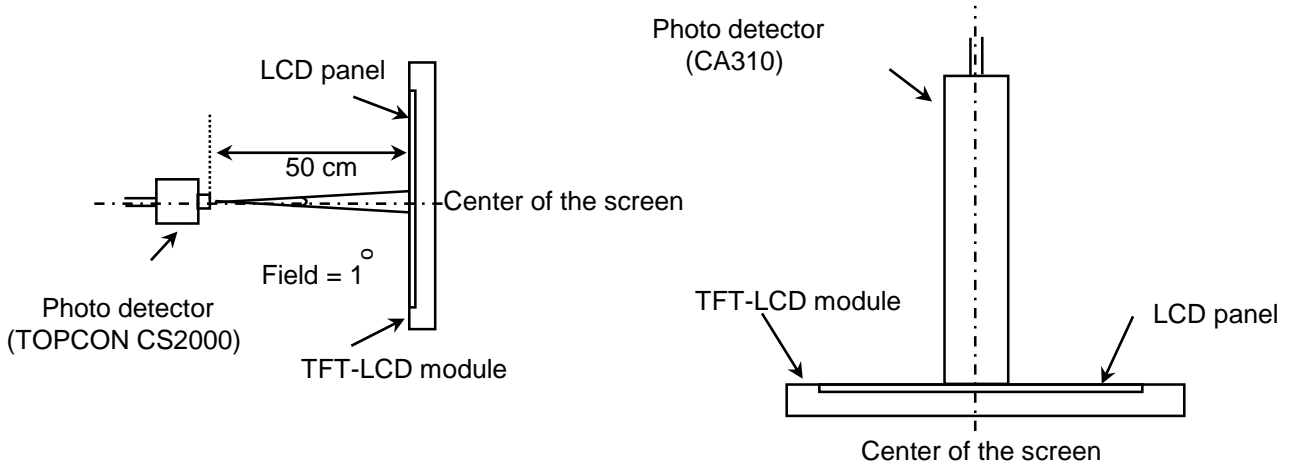

View angel range, uniformity, etc. measurement setup Flicker, measurement setup

Figure 2. White Luminance and Uniformity Measurement Locations (9 points)

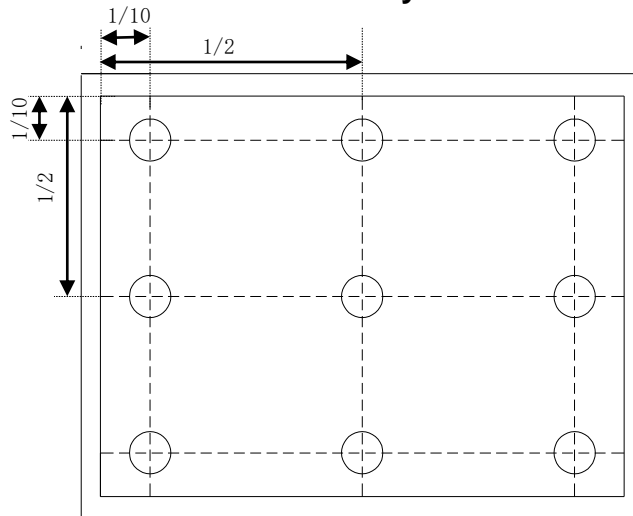

Luminance of white is defined as luminance values of center of the LCD surface. Luminance shall be measured with all pixels in the view field set first to white. This measurement shall be taken at the locations shown in FIGURE 2 for a total of the measurements per display.

The White luminance uniformity on LCD surface is then expressed as : $\Delta Y9 = \text{Minimum Luminance of 9 points} / \text{Maximum Luminance of 9points}$ (see FIGURE 2).

Figure 3. Response Time Testing

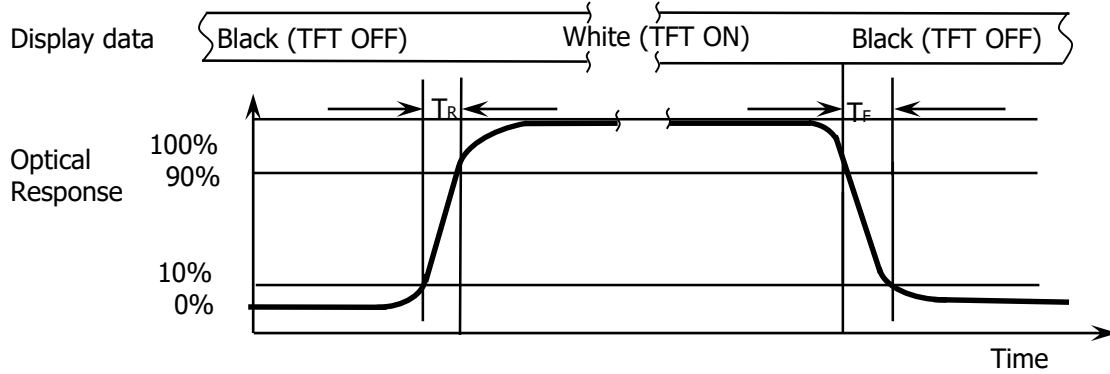

The electro-optical response time measurements shall be made as shown in FIGURE 3 by switching the “data” input signal ON and OFF. The times needed for the luminance to change from 10% to 90% is T_r and 90% to 10% is T_d .

8.0 MECHANICAL CHARACTERISTICS

8.0.1 Dimensional Requirements

<Table 6. Dimensional Parameters>

Parameter	Specification	Unit	Remarks
Active area	476.64(H) × 268.11(V)	mm	
Number of pixels	1920(H) × 1080(V)	pixels	
Pixel pitch	0.24825(H) × 0.24825(V)	mm	
Pixel arrangement	RGB Vertical stripe	-	
Display colors	16.7M	colors	
Display mode	Normally Black	-	
Dimensional outline	495.6(H) × 292.2(V) × 10.7(D) typ.	mm	Detail refer to drawing
Possible Display Type	Landscape and Portrait Enabled	-	
Weight	1.93	Kg	
Bezel width (L/R/U/D)	7.9/7.9/10.5/10.5	mm	
Surface Treatment	Haze 25%, 3H	-	
Back-light	Lower side 1-LED Light bar Type	-	

9.0 RELIABILITY TEST

The Reliability test items and its conditions are shown in below.

<Table 7 Reliability Test Parameters >

No	Test Items	Conditions		Remark
1	High temperature storage test	Ta = 85 °C, 240 hrs		After test ,The Module can normal operation and have no function problem
2	Low temperature storage test	Ta = -30 °C, 240 hrs		
3	High temperature & high humidity operation test	Ta = 40 °C, 90%RH, 240hrs		
4	High temperature & high humidity storage test	Ta = 50 °C, 75%RH, 240hrs		
5	High temperature operation test	Ta = 85 °C, 240hrs		
6	Low temperature operation test	Ta = -20°C, 240hrs		
7	Thermal shock	Ta = -20 °C ↔ 60 °C (0.5 hr), 100 cycle		
8	Packing Vibration Test (non-operating)	Frequenc y Gravity / AMP Period	Random,10 ~ 300 Hz, 30 min/Axis 1.05 Grms X, Y, Z 30 min	
9	Shock test (non-operating)	Gravity	50G	
		Pulse width	11msec, sine wave	
		Direction	±X, ±Y, ±Z Once for each	
10	Electro-static discharge test	Air : 150 pF, 330Ω, 15 KV Contact : 150 pF, 330Ω, 8 KV		
11	Altitude test	Non Operating: 40000 ft, -10°C / 24 Hr, 25°C / 24 Hr, -10°C / 24 Hr		
		Operating: 15000 ft, 0°C / 24 Hr, 25°C / 24 Hr, 50°C / 24 Hr		

BOE	PRODUCT GROUP	REV	ISSUE DATE
	TFT LCD PRODUCT	A	2023.08.20

10.0 Precautions

Please pay attention to the followings when you use this TFT LCD Panel.

10.1 Mounting Precautions

- (1) Use fingerstalls with soft gloves in order to keep display clean during the incoming inspection and assembly process.
- (2) You must mount a module using specified mounting holes (Details refer to the drawings).
- (3) Please make sure to avoid external forces applied to the Source PCB or FPC and D-IC during the process of handling or assembling. If not, It causes panel damage or malfunction.
- (4) Note that polarizers are very fragile and could be easily damaged. Do not touch, push or rub the exposed polarizers with glass, tweezers or anything harder than HB pencil lead. And please do not rub with dust clothes with chemical treatment.
- (5) Do not pull or fold the source D-IC which connect the source PCB or FPC and the panel.
- Do not pull or fold the LED wire.
- (6) After removing the protective film, when the surface becomes dusty, please wipe gently with absorbent cotton or other soft materials like chamois soaks with alcohol or purified water.
- Do not strong polar solvent because they cause chemical damage to the polarizer.
- (7) Wipe off saliva or water drops as soon as possible. Their long time contact with polarizer causes deformations and color fading.
- (8) Protection film for polarizer on the module shall be slowly peeled off just before use so that the electrostatic charge can be minimized.
- (9) Since the LCD is made of glass, do not apply strong mechanical impact or static load onto it. Handling with care since shock, vibration, and careless handling may seriously affect the product. If it falls from a high place or receives a strong shock, the glass may be broken.
- (10) Do not disassemble the module.
- (11) To determine the optimum mounting angle, refer to the viewing angle range in the specification for each model.
- (12) If the customer's set presses the main parts of the LCD, the LCD may show the abnormal display. But this phenomenon does not mean the malfunction of the LCD and should be pressed by the way of mutual agreement.
- (13) Do not drop water or any chemicals onto the LCD's surface.

SPEC. NUMBER	SPEC TITLE DV215FHM-R01 Product Specification	PAGE 19 OF 30
--------------	--	------------------

BOE	PRODUCT GROUP	REV	ISSUE DATE
	TFT LCD PRODUCT	A	2023.08.20

10.2 Operating Precautions

- (1) Be careful for condensation at sudden temperature change. Condensation makes damage to polarizer or electrical contacted parts. And after fading condensation, smear or spot will occur.
- (2) Module has high frequency circuits. Sufficient suppression to the electromagnetic interference shall be done by system manufacturers. Grounding and shielding methods may be important to minimized the interference.
- (3) The electrochemical reaction caused by DC voltage will lead to LCD degradation, so DC drive should be avoided.
- (4) The LCD modules use C-MOS LSI drivers, so customers are recommended that any unused input terminal would be connected to Vdd or Vss, do not input any signals before power is turn on, and ground you body, work/assembly area, assembly equipments to protect against static electricity.
- (5) Do not exceed the absolute maximum rating value. (supply voltage variation, input voltage variation, variation in part contents and environmental temperature, and so on) Otherwise the Module may be damaged.
- (6) Design the length of cable to connect between the connector for back-light and the converter as short as possible and the shorter cable shall be connected directly.
The longer cable between that of back-light and that of converter may cause the luminance of LED to lower and need a higher startup voltage(Vs).
- (7) Connectors are precise devices for connecting PCB and transmitting electrical signals. Operators should insert and unplug MDL in parallel when assembling MDL.
- (8) Do not connect or disconnect the cable to/ from the module at the "Power On" condition.
- (9) When the module is operating, do not lose CLK, ENAB signals. If any one these signals is lost, the LCD panel would be damaged.
- (10) Obey the supply voltage sequence. If wrong sequence is applied, the module would be damaged.
- (11) Do not re-adjust variable resistor or switch etc.

10.3 Electrostatic Discharge Control

- (1) Since a module is composed of electronic circuits, it is not strong to electrostatic discharge. Make certain that treatment persons are connected to ground through wrist band etc. And don't touch interface pin directly. Keep products as far away from static electricity as possible.
- (2) Avoid the use work clothing made of synthetic fibers. We recommend cotton clothing or other conductivity-treated fibers.

SPEC. NUMBER	SPEC TITLE DV215FHM-R01 Product Specification	PAGE 20 OF 30
--------------	--	------------------

BOE	PRODUCT GROUP	REV	ISSUE DATE
	TFT LCD PRODUCT	A	2023.08.20

10.4 Precautions for Strong Light Exposure

It is not allowed to store or run directly in strong light or in high temperature and humidity for a long time; Strong light exposure causes degradation of polarizer and color filter.

10.5 Storage Precautions

When storing modules as spares for a long time, the following precautions are necessary.

- (1) The polarizer surface should not come in contact with any other object.
It is recommended that they be stored in the container in which they were shipped.
Temperature : 5 ~ 40 °C
- (2) Humidity : 35 ~ 75 %RH
- (3) Period : 6 months
- (4) Control of ventilation and temperature is necessary.
- (5) Please make sure to protect the product from strong light exposure, water or moisture.
Be careful for condensation.
- (6) Store in a polyethylene bag with sealed so as not to enter fresh air outside in it.
- (7) Do not store the LCD near organic solvents or corrosive gasses.
- (8) Please keep the Modules/OC at a circumstance shown below Fig.

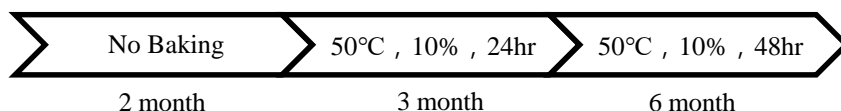

10.6 Precautions for Protection Film

- (1) Remove the protective film slowly, keeping the removing direction approximate 30-degree not vertical from panel surface, If possible, under ESD control device like ion blower, and the humidity of working room should be kept over 50%RH to reduce the risk of static charge.
- (2) In handling the LCD, wear non-charged material gloves. And the conducting wrist to the earth and the conducting shoes to the earth are necessary.

10.7 Appropriate Condition for Display

- (1) Normal operating condition
 - Temperature: 0 ~ 40°C
 - Operating Ambient Humidity : 10 ~ 90 %
 - Display pattern: dynamic pattern (Real display)
 - Suitable operating time: under 16 hours a day.
- (2) Special operating condition

If the product will be used in extreme conditions such as high temperature, humidity, display patterns or 7*24hrs operation time etc., It is strongly recommended to contact BOE for Application engineering advice. Otherwise, its reliability and function may not be guaranteed.

- (3) Black image or moving image is strongly recommended as a screen save.

SPEC. NUMBER	SPEC TITLE DV215FHM-R01 Product Specification	PAGE 21 OF 30
--------------	--	------------------

BOE	PRODUCT GROUP	REV	ISSUE DATE
	TFT LCD PRODUCT	A	2023.08.20

- (4) Lifetime in this spec. is guaranteed only when commercial display is used according to operating usages.
- (5) Please contact BOE in advance when you display the same pattern for a long time.
- (6) If the Module keeps displaying the same pattern for a long period of time, the image may be “sticked“ or “turn off” to the screen. To avoid image sticking, it is recommended to use a screen saver.
- (7) Do not exceed the absolute maximum rating value. (supply voltage variation, input voltage variation, variation in part contents and environmental temperature, and so on) Otherwise the Module may be damaged.
- (8) Dew drop atmosphere should be avoided.
- (9) The storage room should be equipped with a good ventilation facility and avoid to expose to corrosive gas , which has a temperature controlling system.
- (10) When expose to drastic fluctuation of temperature (hot to cold or cold to hot) ,the LCD may be affected; Specifically, drastic temperature fluctuation from cold to hot ,produces dew on the LCD's surface which may affect the operation of the polarizer and the LCD.
- (11) Response time will be extremely delayed at lower temperature than the operating temperature range and on the other hand at higher temperature LCD may turn black at temperature above its operational range. However those phenomena do not mean malfunction or out of order with the LCD. The LCD will revert to normal operation once the temperature returns to the recommended temperature range for normal operation

10.8 Others

A. LC Leak

- If the liquid crystal material leaks from the panel, it is recommended to wash the LC with acetone or ethanol and then burn it.
- In case of contact with hands, skin or clothes, it has to be washed away thoroughly with soap.
- If LC in mouth, mouth need to be washed, drink plenty of water to induce vomiting and follow medical advice.
- If LC touch eyes, eyes need to be washed with running water at least 15 minutes.

B. Rework

- When returning the module for repair or etc., Please pack the module not to be broken. We recommend to use the original shipping packages.

SPEC. NUMBER	SPEC TITLE DV215FHM-R01 Product Specification	PAGE 22 OF 30
--------------	--	------------------

BOE	PRODUCT GROUP	REV	ISSUE DATE
	TFT LCD PRODUCT	A	2023.08.20

11.0 LABEL

(1) Product label

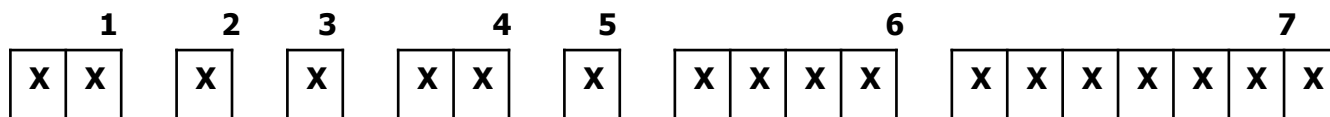

1. Control Number

2. Rank / Grade

3. Line Classification

4. Year (2001 : 01, 2002 : 02, ...)

5. Month (1,2,3, ... , 9, X, Y, Z)

6. Internal Use

7. Serial Number

(2) High voltage caution label

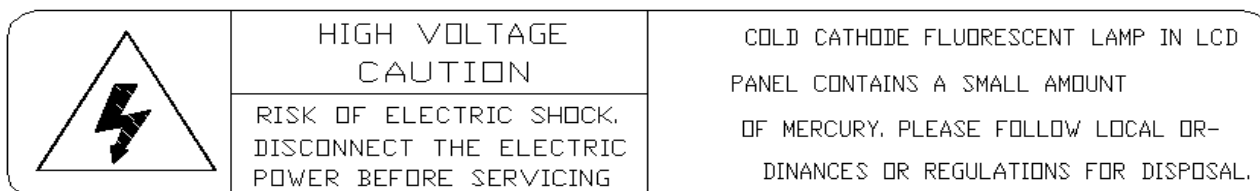

SPEC. NUMBER	SPEC TITLE DV215FHM-R01 Product Specification	PAGE 23 OF 30
--------------	--	------------------

(3) Box label

- Label Size : 108 mm (L) × 56 mm (W)
- Contents
 - Model : DV215FHM-R01
 - Q`ty : Module 12 Q`ty in one box
 - Serial No. : Box Serial No. See next page for detail description.
 - Date : Packing Date
 - FG Code : FG Code of Product

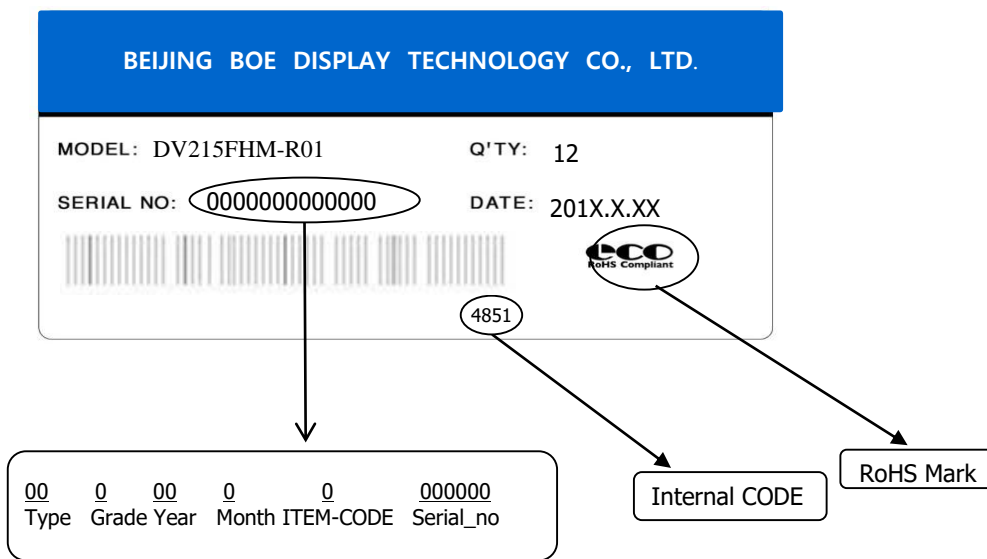

12.0 PACKING INFORMATION

12.0.1 Packing Order

-Put 1Pcs EPO Bottom into the box

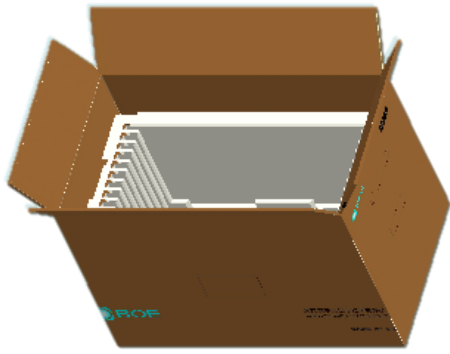

-Put each module into a PE bag
-Put 12Pcs MDL into the box

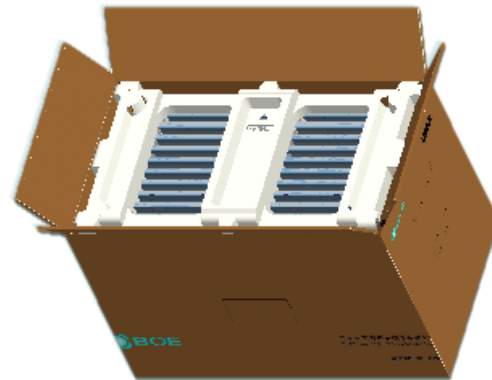
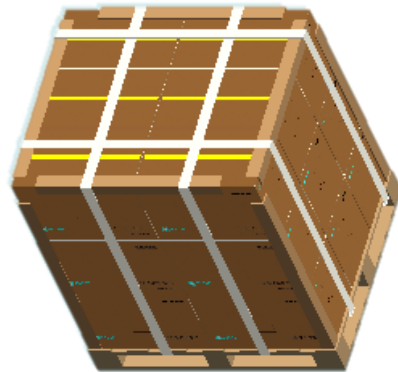
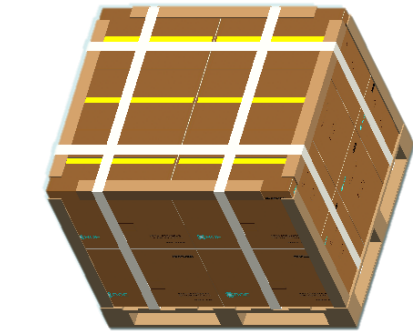
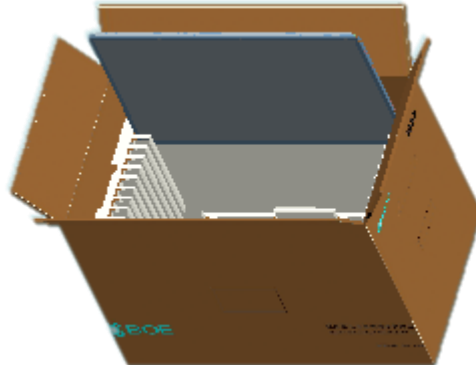

-Put 1 Pcs EPO cover in and seal the box.

-Put the boxes on the Pallet

12boxes/Pallet:6boxes per layer, total 2 layers

18boxes/Pallet:6Boxes per layer, total 3 layers

-Place paper corners and wrap film around the boxes

-Pack with 4 packing belts

12.0.2 Packing Specification and Note

Item	Specification			Remark
	Q'ty	Dimension(mm)	Weight (kg)	
MDL	1	495.6 (H) × 292.2 (V) × 10.7 (D) typ.	2.05	-
Box	1	554*324*390 mm	1.2	
Packing Box	12 pcs/Box	554*324*390 mm	25.4	
Pallet	1	1140(L)×1000(W)×130(H)	18	-
Packing Pallet	12Box/Pallet	1140(H)×1000(H)×910(H)	325	-
	18Box/Pallet	1140(H)×1000(H)×1300(H)	465	

13.0 MECHANICAL OUTLINE DIMENSION

Figure 4. TFT-LCD Module Outline Dimensions (Front view , Horizontal placement)

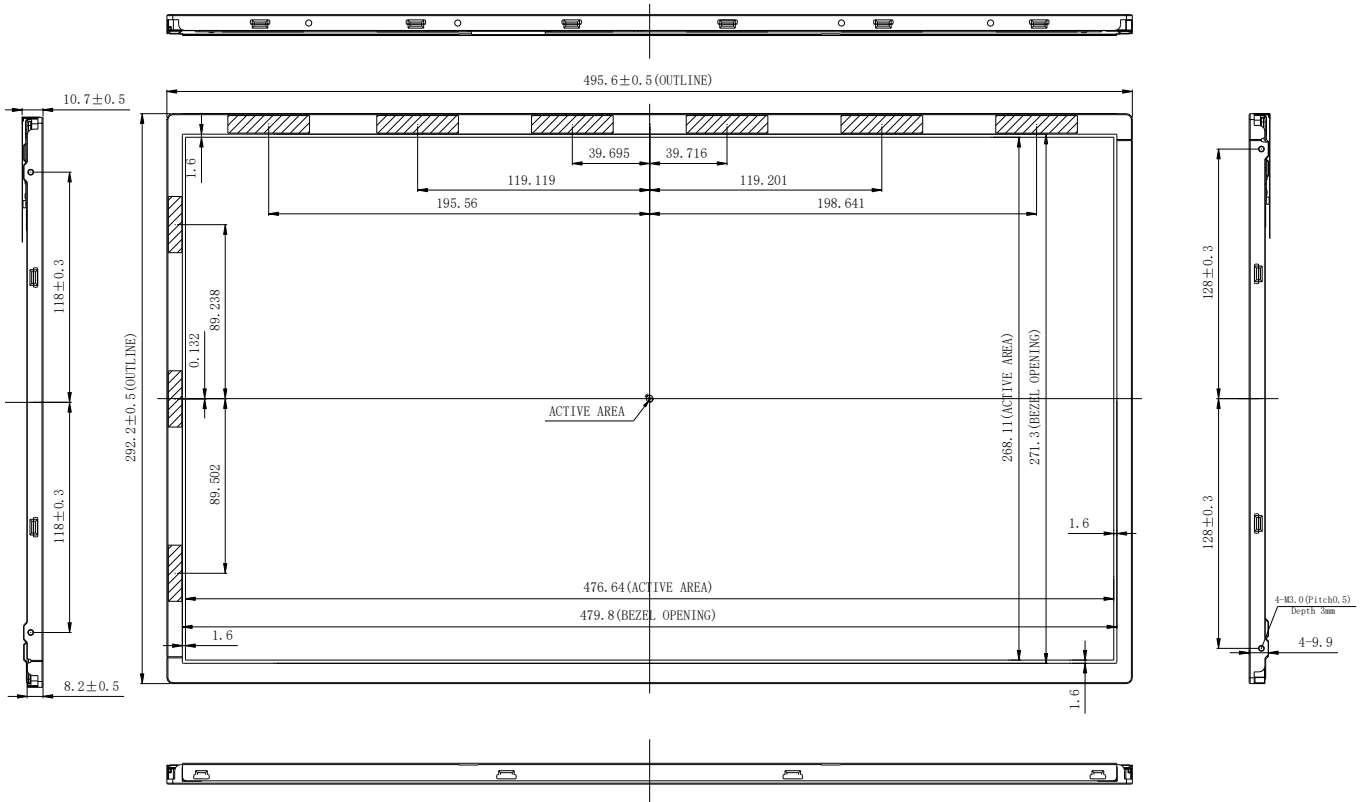

SPEC. NUMBER

SPEC TITLE

DV215FHM-R01 Product Specification

PAGE

27 OF 30

Figure 5. TFT-LCD Module Outline Dimensions (Rear view , Horizontal placement)

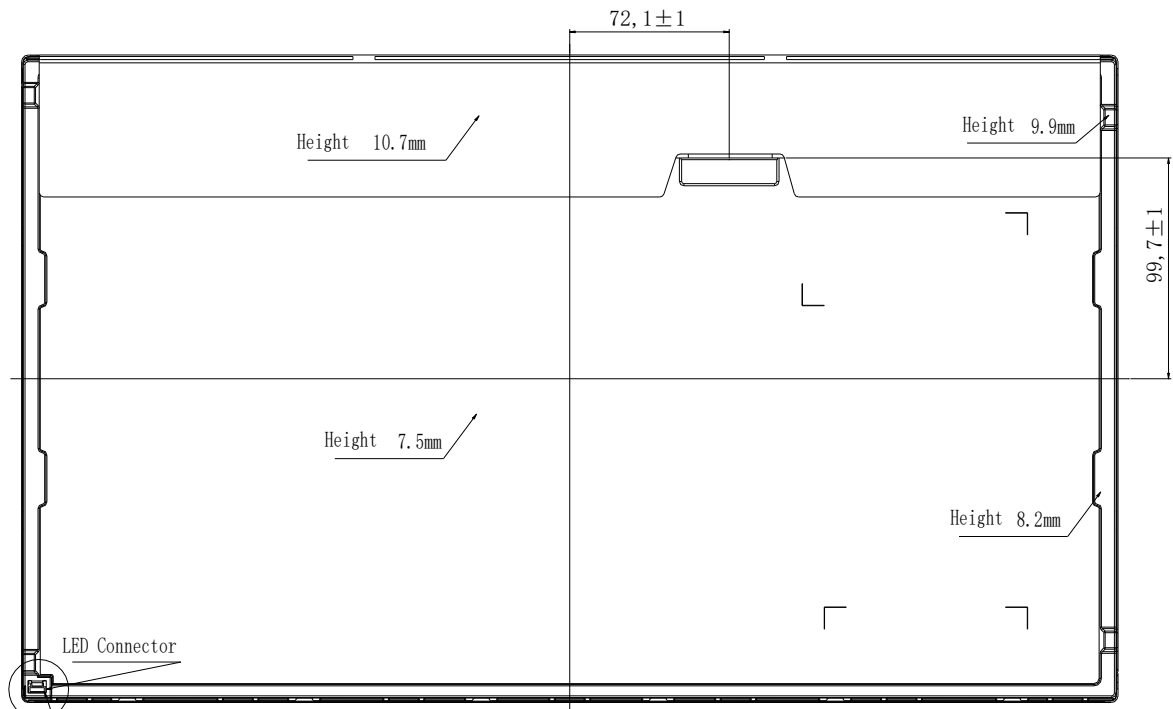

LED Connector on the ground side When Placed Vertically(Horizontally)

LED Connector PIN MAP

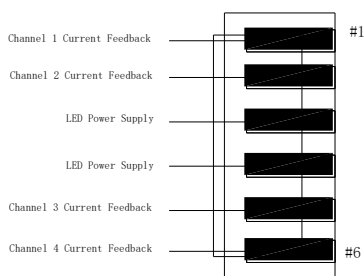

NOTE:

1. 1/F CONNECTOR SPECIFICATION
IS100-L300-C23 (UJU)
2. LED CONNECTOR SPECIFICATION
3707K-Q06N-08X (ENTERY)
3. Torque of userhole: 3.0~4.0kgf • ~cm.
4. Tilt and partial desposition tolerance of display area as following:
 - (1) Y-direction: | A-B | ≤ 1.4
 - (2) X-direction: | C-D | ≤ 1.4

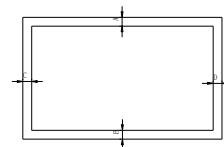

5. Unspecified tolerances to be ±0.5mm.
6. The COF area is weak & sensitive, so don't press the COF area.
7. Outside Flatness : 0.6mm MAX.

Figure 6. TFT-LCD Module Outline Dimensions (Front view , Vertical placement)

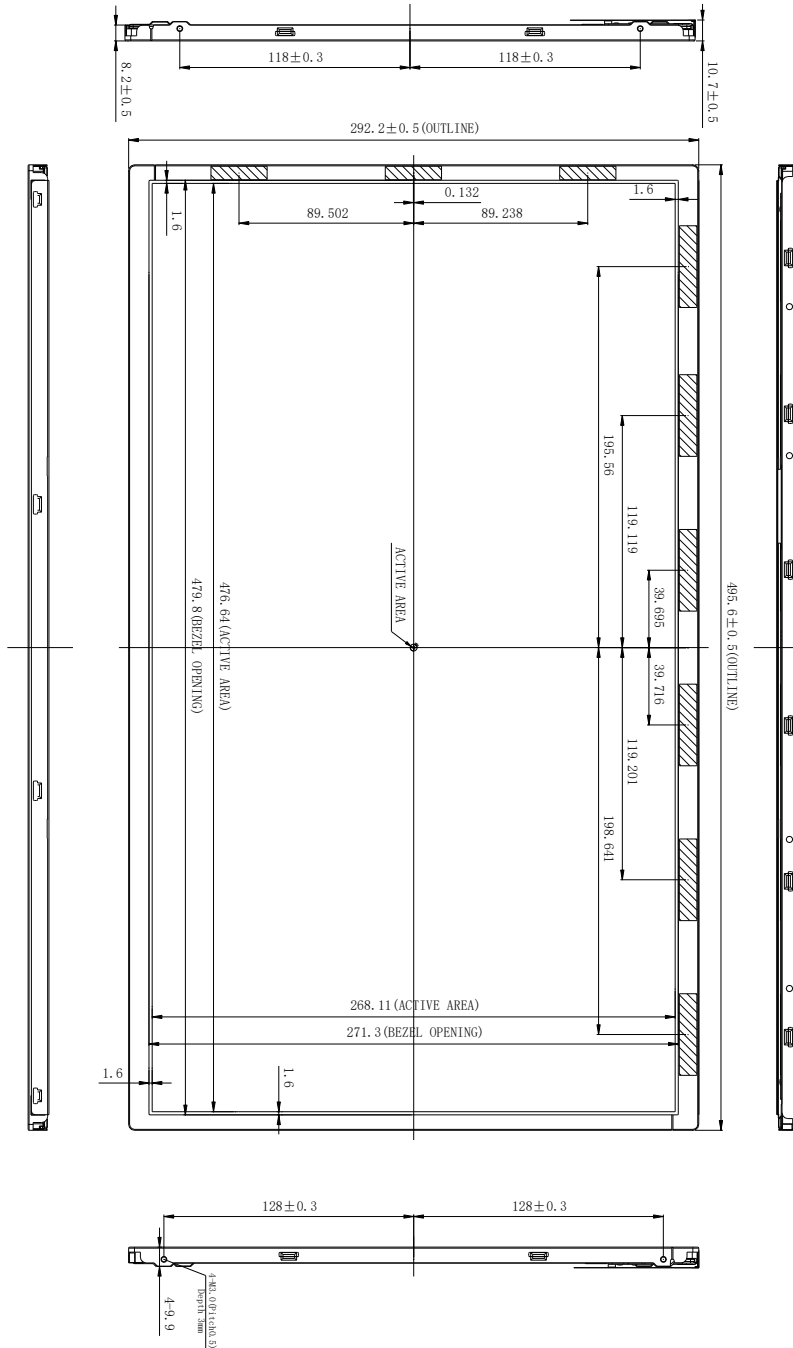

SPEC. NUMBER

SPEC TITLE
DV215FHM-R01 Product Specification

PAGE
29 OF 30

Figure 7. TFT-LCD Module Outline Dimensions (Rear view , Vertical placement)

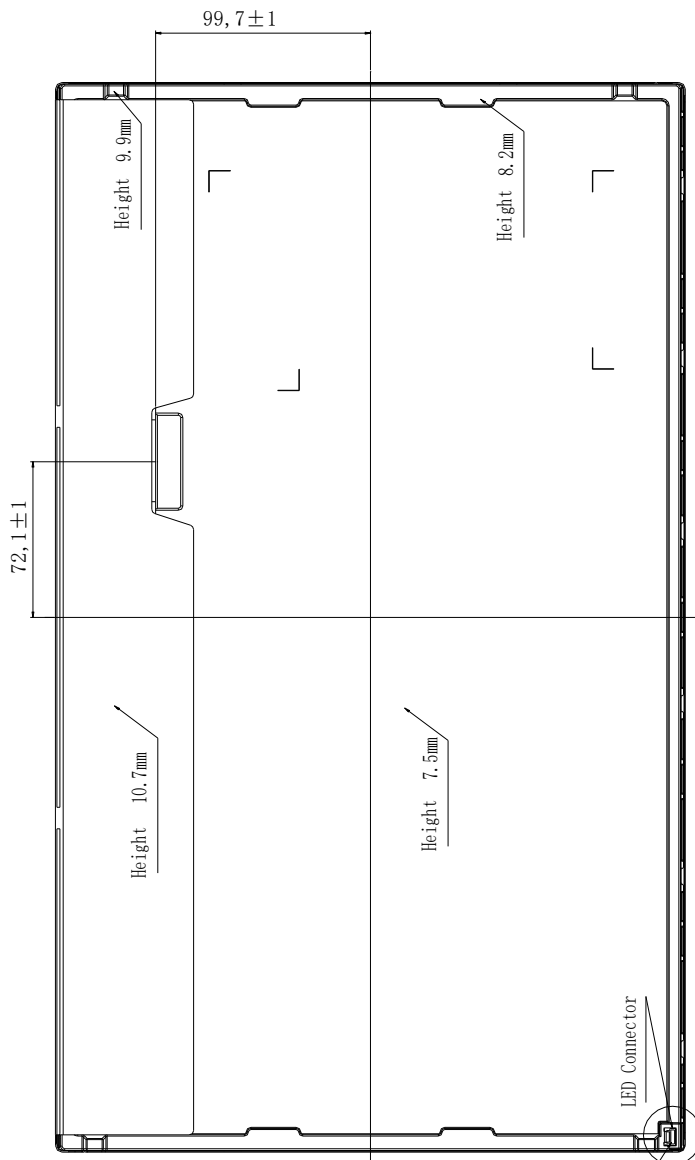

LED Connector on the ground side When Placed Vertically(Horizontally)

NOTE:

1. I/F CONNECTOR SPECIFICATION
IS100-L300-C23 (UJU)
2. LED CONNECTOR SPECIFICATION
3707K-Q06N-08X (ENTERY)
3. Torque of userhole: $3.0 \sim 4.0 \text{ kgf} \cdot \text{cm}$.
4. Tilt and partial desposition tolerance of display area as following:
 - (1) Y-direction: $|A-B| \leq 1.4$
 - (2) X-direction: $|C-D| \leq 1.4$

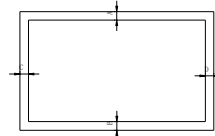

5. Unspecified tolerances to be $\pm 0.5 \text{ mm}$.
6. The COF area is weak & sensitive, so don't press the COF area.
7. Outside Flatness : 0.6 mm MAX .

LED Connector PIN MAP

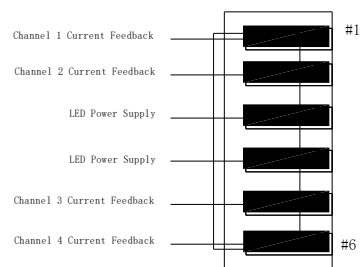

DATA MODUL

Passion Displayed



All good things come in threes:

With **Hardware**, **Software** and **Services**, we realise unique display solutions that turn your ideas into reality.

www.data-modul.com

