



SPECIFICATION



P1560FHF2MA00

15.6" - FHD – LVDS

Version: 1.0

Date: 22.02.2023

Note: This specification is subject to change without prior notice

CONTENTS

1. SUMMARY	1
1.1 General Description	1
1.2 Features	1
2. GENERAL SPECIFICATIONS	1
3. INPUT / OUTPUT TERMINALS	3
3.1 CN1 Pin assignment (LCD Interface)	3
4. ABSOLUTE MAXIMUM RATINGS	5
5. ELECTRICAL CHARACTERISTICS	6
5.1 DC Characteristics for Panel Driving	6
5.2 DC Characteristics for Backlight Driving	6
5.3 Recommended Power ON/OFF Sequence	7
5.4 LCD Module Block Diagram	8
5.5 LVDS DC electrical characteristics	9
5.6 LVDS AC electrical characteristics.....	9
6. TIMING CHARACTERISTICS	11
6.1 LVDS signal timing characteristics.....	11
6.2 LVDS data input format	12
7. OPTICAL CHARACTERISTICS	13
8. RELIABILITY TEST	16
9. MECHANICAL DRAWING	17
10. PACKING DRAWING	18
11. PRECAUTIONS FOR USE OF LCD MODULES	18
11.1 Handling Precautions.....	18
11.2 Storage precautions.....	19
11.3 Transportation Precautions	19
11.4 Screen saver Precautions	19
11.5 Safety Precautions.....	19

1. Summary

1.1 General Description

This is a 15.6 inch a-Si TFT-LCD module with Normal- Black technology. It is composed of a TFT-LCD panel, a driver circuit, PCB, and a LED backlight unit.

1.2 Features

- Ultra-wide viewing angle (Super Fine TFT (SFT))
- High resolution(FHD)
- High contrast ratio(1500:1)
- Interface: 2 port LVDS(8bit)
- Surface treatment(Anti-glare)

- Acquisition product for UL62368-1/CSA C22.2 Noxxxxxx.
- Compliant with the European RoHS Directive (2011/65/EU) and Delegated Directive (2015/863/EU, Amending Annex II of 2011/65/EU)

2. General Specifications

	Feature	Spec	Unit
Display Spec	Size	15.6 inches	
	Resolution	1920(RGB)x1080	
	Pixel Pitch	0.17925x0.17925	mm
	TFT Active Area	344.16*193.59	mm
	Technology Type	a-Si	
	Pixel Configuration	R.G.B Vertical Stripe	
	Display Mode	SFT, Normally Black	
	Surface Treatment	Anti-Glare	
	Viewing Direction	All	
Mechanical Characteristics	LCM (W x H x D)	363.8*215.9	mm
	Weight	TBD	g
Optical Characteristics	Luminance	Typ:1000	cd/m ²
	Contrast Ratio	Typ:1500:1	
	NTSC	Typ:72	%
	Viewing Angle	88/88/88/88	degree
Electrical Characteristics	Interface	2 Port LVDS(8bit)	
	Color Depth	16.7 Million	color
	Power Consumption	LCD: TBD Backlight:TBD	mW

Table 2.1 General TFT Specifications

3. Input / Output Terminals

3.1 CN1 Pin assignment (LCD Interface)

Connector Information	
LCD Module connector	MSBKT2407P30HB
Matching connector	FI-X30HL (Locked Type)

Table 3.1.1 Connector information

No	Symbol	I/O	Description	Comment
1	ORX0-	I	-LVDS differential data input (R0~R5,G0)	
2	ORX0+	I	+LVDS differential data input (R0~R5 G0)	
3	ORX1-	I	-LVDS differential data input (G1~G5,B0,B1)	
4	ORX1+	I	+LVDS differential data input (G1~G5,B0,B1)	
5	ORX2-	I	-LVDS differential data input (B2~B5,-,-,DE)	
6	ORX2+	I	+LVDS differential data input (B2~B5,-,-,DE)	
7	GND	P	Ground	
8	ORXC-	I	-LVDS differential Clock input	
9	ORXC+	I	+LVDS differential Clock input	
10	ORX3-	I	-LVDS differential data input (R6~R7,G6~G7,B6~B7)	
11	ORX3+	I	+LVDS differential data input (R6~R7,G6~G7,B6~B7)	
12	ERX0-	I	-LVDS differential data input (R0~R5,G0)	
13	ERX0+	I	+LVDS differential data input (R0~R5,G0)	
14	GND	P	Ground	
15	ERX1-	I	-LVDS differential data input (G1~G5,B0,B1)	
16	ERX1+	I	+LVDS differential data input (G1~G5,B0,B1)	
17	GND	P	Ground	
18	ERX2-	I	-LVDS differential data input (B2~B5,-,-,DE)	
19	ERX2+	I	+LVDS differential data input (B2~B5,-,-,DE)	
20	ERXC-	I	-LVDS differential Clock input	
21	ERXC+	I	+LVDS differential Clock input	
22	ERX3-	I	-LVDS differential data input (R6~R7,G6~G7,B6~B7)	
23	ERX3+	I	+LVDS differential data input (R6~R7,G6~G7,B6~B7)	
24	GND	P	Ground	
25	NC	N	No connection	
26	NC	N	No connection	
27	NC	N	No connection	
28	VDD	P	POWER	
29	VDD	P	POWER	
30	VDD	P	POWER	

Table 3.1.2 Pin Assignment for LCD Interface

Note1: I/O definition: I---Input, O---Output, P---Power/Ground, N---No connection

Note2: All of the GND pins should be connected to the system ground.

Note3: This LCD module supports SYNC & DE mode, the pin setting is different from each other. Please refer to the descriptions.

Note4: Display direction



3.2 CN2 Pin assignment (BL interface)

Connector Information	
LCD Module connector	MSB24038P8
Matching connector	P24038P8

Table 3.2.1 BL Connector information

No	Symbol	I/O	Description	Comment
1	VLED	P	Backlight power supply:+12V	
2	VLED	P	Backlight power supply:+12V	
3	VLED	P	Backlight power supply:+12V	
4	GND	P	Ground	
5	GND	P	Ground	
6	GND	P	Ground	
7	BL_EN	I	Backlight on/off control pin; High-on, low-off	
8	PWM	I	Dimming control signal	

Table 3.2.2 Pin Assignment for BL Interface

4. Absolute Maximum Ratings

Item	Symbol	MIN	MAX	Unit	Remark
Power Voltage	VCC	-0.3	5.0	V	Note1
Operating Temperature	Top	-30	85	°C	
Storage Temperature	Tst	-30	85	°C	
Relative Humidity Note2	RH	--	≤95	%	Ta≤40°C
		--	≤85	%	40°C<Ta≤50°C
		--	≤55	%	50°C<Ta≤60°C
		--	≤36	%	60°C<Ta≤70°C
		--	≤24	%	70°C<Ta≤80°C
Absolute Humidity	AH	--	≤70	g/m ³	Ta>70°C

Table 4.1 Absolute Maximum Ratings

Note1: Input voltage include all in put data.

Note2: Ta means the ambient temperature. It is necessary to limit the relative humidity to the specified temperature range. Condensation on the module is not allowed.

Note3: The absolute maximum rating values of this product are not allowed to be exceeded at any times. A module should be used with any of the absolute maximum ratings exceeded, the characteristics of the module may not be recovered, or in an extreme condition, the module may be permanently damaged.

5. Electrical Characteristics

5.1 DC Characteristics for Panel Driving

Item	Symbol	MIN	TYP	MAX	Unit	Remark
Supply Voltage	VCC	3.2	3.3	3.4	V	
VCC current	Ivcc	--	TBD	--		
Input Signal Voltage	Low Level	VIL	DGND	--	0.2×VCC	V
	High Level	VIH	0.8×VCC	--	VCC	V
Power Consumption	60Hz	P	--	TBD	--	mW
Inrush current	Irush	--	--	TBD	A	Note1

Table 5.1.1 Operating Voltages

Note1: To test the current dissipation, using the “white pattern” shown

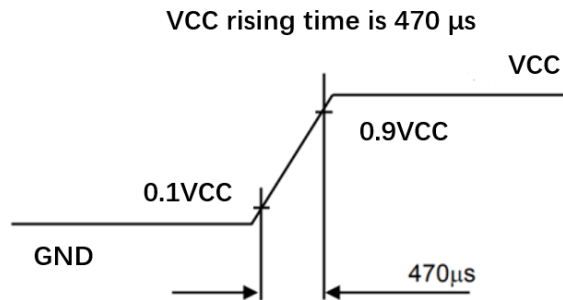

5.2 DC Characteristics for Backlight Driving

Item	Symbol	MIN	TYP	MAX	Unit	Remark	
VLED	VLED	10.8	12	13.2	V		
VLED Current	I _{VLED}	--	TBD	--	mA		
Backlight Consumption Power	P	--	TBD	--	mW		
PWM frequency	F	200	--	20K	HZ		
PWM duty	D	3	--	100	%		
PWM signal	High level	--	1.8	3.3	5		V
	Low level	--	0	-	0.8		V
LED_EN signal	High level	--	1.8	3.3	5		V
	Low level	--	0	-	0.8		V
LED life time	--	50000	--	-	Hrs		

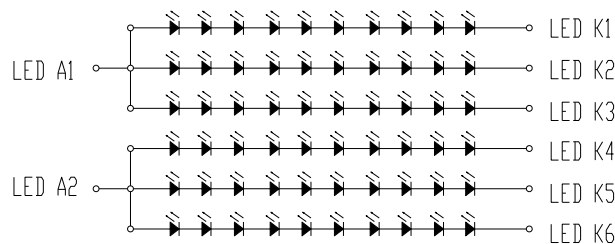

Table 5.2.1 LED Backlight Characteristics

Note1: According to LED driver IC characteristics, the minimum value of VELD_PWM duty may vary with VLED_PWM frequency, higher the frequency, bigger the duty

Note2: Optical performance should be evaluated at Ta=25°C only.

Note3: If LED is driven by high current, high ambient temperature & humidity condition. The life time of LED will be reduced.

Note4: Operating life means brightness goes down to 50% of initial brightness. Typical operating life time is estimated data.

5.3 Recommended Power ON/OFF Sequence

Symbol	Min	Typ	Max	Unit	Remark
t1	1	-	3	ms	
t2	1	-	50	ms	
t3	200	-	-	ms	
t4	0.5	-	10	ms	
t5	2	-	-	ms	
t6	25	-	-	ms	
t7	2	-	-	ms	
t8	2	-	-	ms	
t9	1	-	10	ms	
t10	200	-	-	ms	
t11	2	-	-	ms	
t12	1	-	20	ms	
t13	1000	-	-	ms	

Table 5.3.1 Power on/off sequence

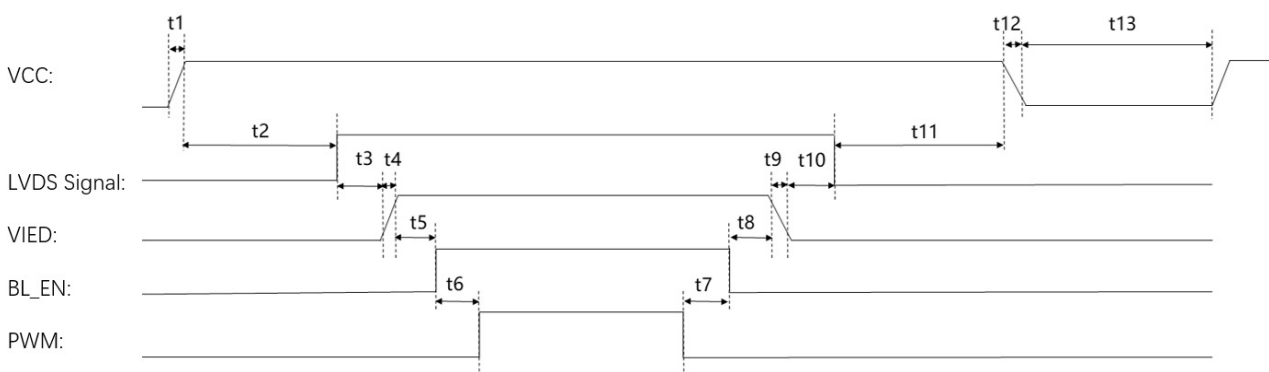

Figure 5.3.1 Power on/off sequence

Note1: It is advised that backlight turned on later than display stabled.

Note2: The low level of these signals and analog powers are GND level.

Note3: All of the power and signals should be kept at GND level before power on. If there are residual voltages on them, the LCD might not work properly.

Note4: The power on/off sequence is the first version. It will be updated when the design is fixed.

Note5: Keep LED_EN at low level until the display has stabilized.

5.4 LCD Module Block Diagram

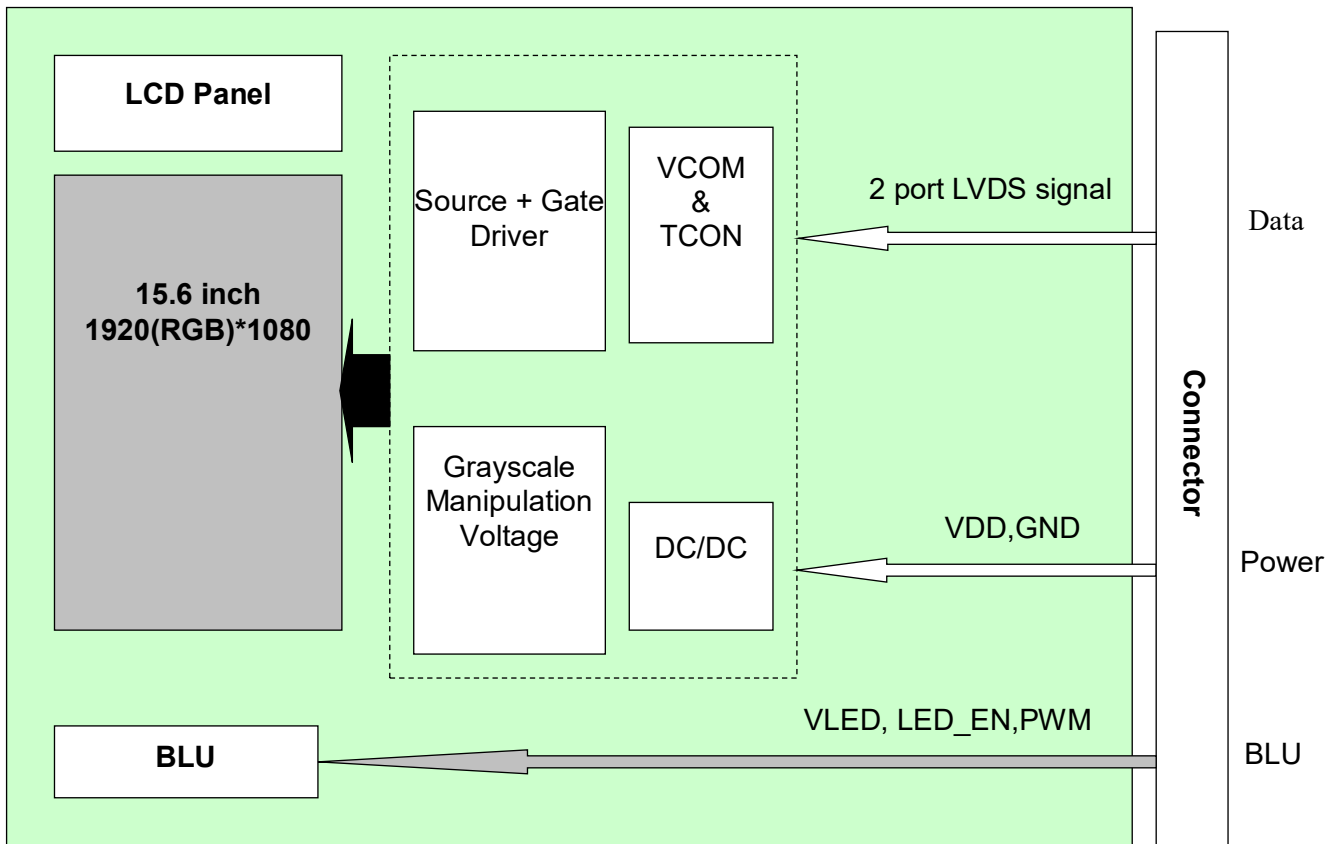

Figure 5.4.1 LCD Module Block Diagram

5.5 LVDS DC electrical characteristics

Parameter	Symbol	Min	Typ	Max	Unit	Condition
Differential Input high Threshold voltage	R_{xVTH}	-	-	+0.1	V	$R_{xVCM}=1.2V$
Differential Input Low Threshold voltage	R_{xVTL}	-0.1	-	-	V	
Input voltage range (signaled-end)	R_{xVIN}	0	-	VCC-1.0	V	
Differential Input common Mode voltage	R_{xVCM}	0.6	1.2	$2.4- V_{ID} /2$	V	
Differential Input voltage	$ V_{ID} $	0.2	0.4	0.6	V	

Table 5.5.1 LVDS DC Characteristics

Single end signals n=0,1,2,3

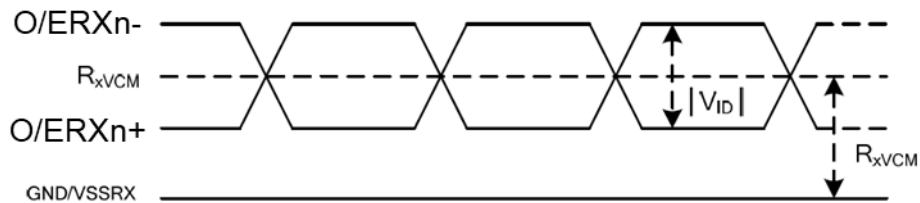

Differential signals

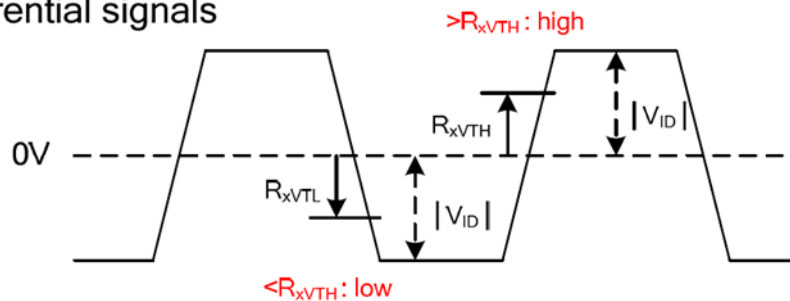

Figure 5.5.1 LVDS DC Characteristics

5.6 LVDS AC electrical characteristics

Parameter	Symbol	Min	Typ	Max	Unit	Condition
Clock frequency	R_{xFCLK}	66.5	-	75	MHz	
1data bit time	UI	-	1/7	-	RxTCLK	
Clock high time	T_{LVCH}	-	4	-	UI	
Clock low time	T_{LVCL}	-	3	-	UI	
Position1	T_{pos1}	-0.25	0	0.25	UI	
Position2	T_{pos2}	0.75	-	1.25		
Position3	T_{pos3}	0.75	1	1.25		
Position4	T_{pos4}	1.75	-	2.25		
Position5	T_{pos5}	1.75	2	2.25		
Position6	T_{pos6}	2.75	-	3.25		
Position7	T_{pos7}	2.75	3	3.25		

Position8	Tpos8	3.75	-	4.25	UI	
Position9	Tpos9	3.75	4	4.25		
Position10	Tpos10	4.75	-	5.25		
Position11	Tpos11	4.75	5	5.25		
Position12	Tpos12	5.75	-	6.25		
Position13	Tpos13	5.75	6	6.25		
Position14	Tpos14	6.75	-	7.25		
PLL wake-up time	T _{enPLL}	-	-	150	μS	

Table 5.6.1 LVDS AC Characteristics

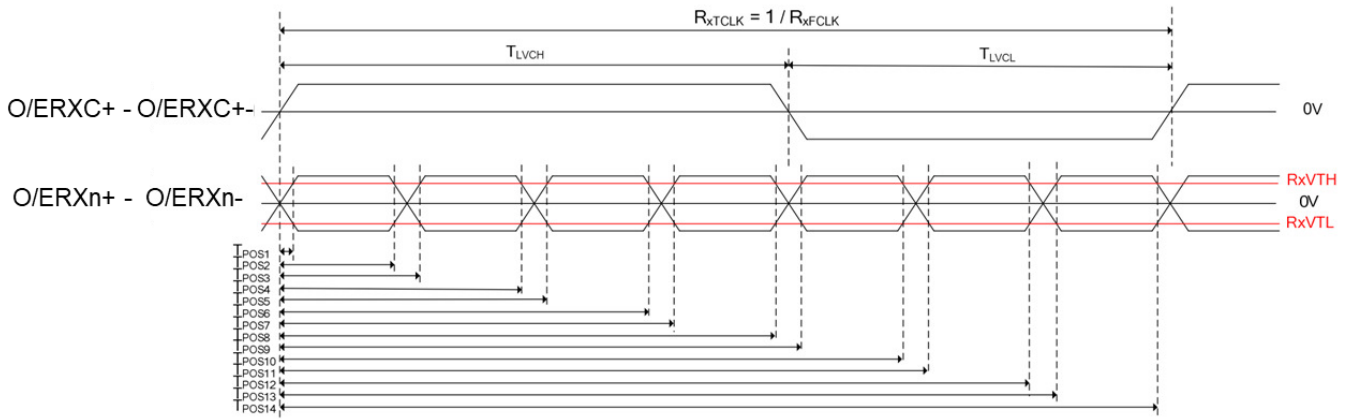

Figure 5.6.2 LVDS DC Characteristics

6. Timing Characteristics

6.1 LVDS signal timing characteristics

Parameter	Symbol	Value			Unit	Note
		min	typ	max		
CLK frequency	t_{clk}	66.5	67.87	75	MHZ	
Horizontal blanking time	t_{HBT}	48	50	99	t_{clk}	$t_{HBP} + t_{HFP}$
Horizontal display area	t_{HD}	960			t_{clk}	
Horizontal period	t_H	1008	1010	1059	t_{clk}	
Horizontal pulse width	t_{HPW}	--	2	--	t_{clk}	
Vertical blanking time	t_{VBT}	20	40	100	t_H	$t_{VBP} + t_{VFP}$
Vertical display area	t_{VD}	1080			t_H	
Vertical period	t_V	1100	1120	1180	t_H	
Vertical pulse width	t_{VPW}	--	2	--	t_H	
Frame rate	Fr	--	60	--	HZ	

Table 6.1.1 Input Timing Parameters

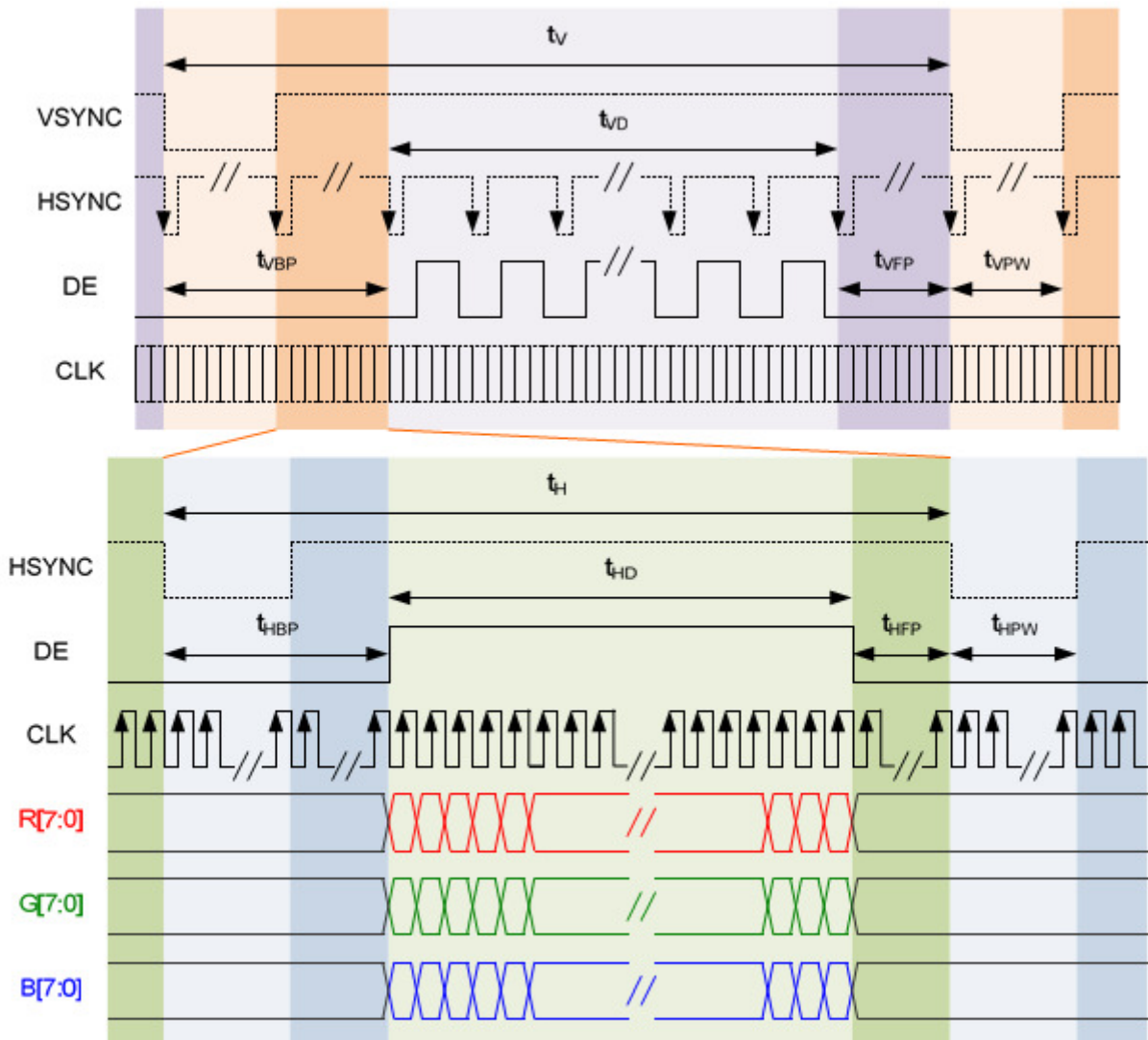

Figure 6.1.1 Clock and Data Input Timing Diagram

6.2 LVDS data input format

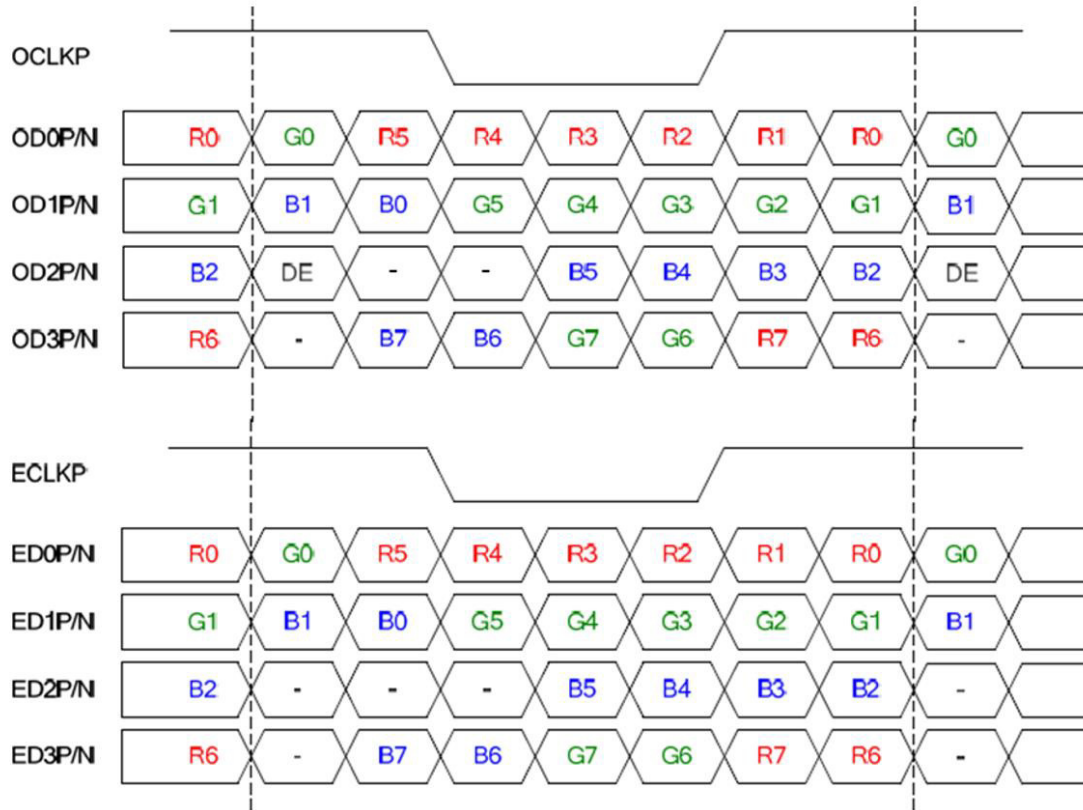

Table 6.2.1 LVDS data mapping (VESA standard)

7. Optical Characteristics

Item	Symbol	Condition	Min	Typ	Max	Unit	Remark	
View Angles	θT	$CR \geq 10$	78	88	--	degree	Note2,3	
	θB		78	88	--			
	θL		78	88	--			
	θR		78	88	--			
Contrast Ratio	CR	$\theta=0^\circ$	1500	--	--		Note 3	
Response Time	T_{ON}	25°C	--	35	40	ms	Note 4	
	T_{OFF}							
Chromaticity	White	x	--	0.313	--		Note 1,5	
		y	--	0.329	--			
	Red	x	Backlight is on	--	--	--		Note 1,5
		y		--	--	--		
	Green	x		--	--	--		Note 1,5
		y		--	--	--		
	Blue	x		--	--	--		Note 1,5
		y		--	--	--		
Uniformity	U	-		70	75	--	%	Note 6
NTSC	-	-		67	72	--	%	Note 5
Luminance	L	-	-	1000	--	cd/m ²	Note 7	

Table 7.1 Optical Parameters

Test Conditions:

1. The ambient temperature is 25°C.
2. The test systems refer to Note1 and Note2.

Note1: Definition of optical measurement system.

The optical characteristics should be measured in dark room. After 5 Minutes operation, the optical characteristics are measured at the center point of the LCD screen.

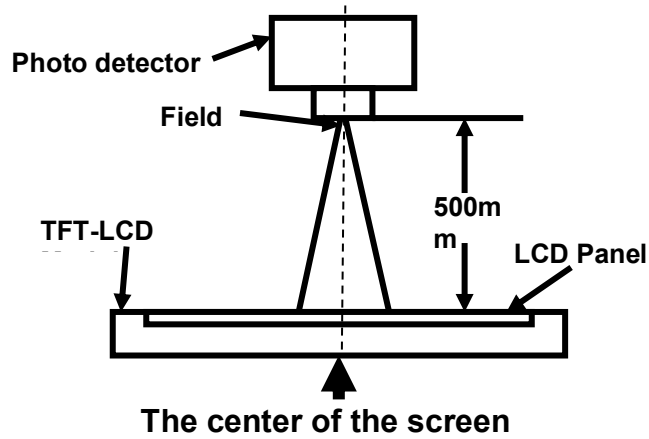

Fig1. Measurement Set Up

Note2: Definition of viewing angle range and measurement system. Viewing angle is measured at the center point of the LCD .

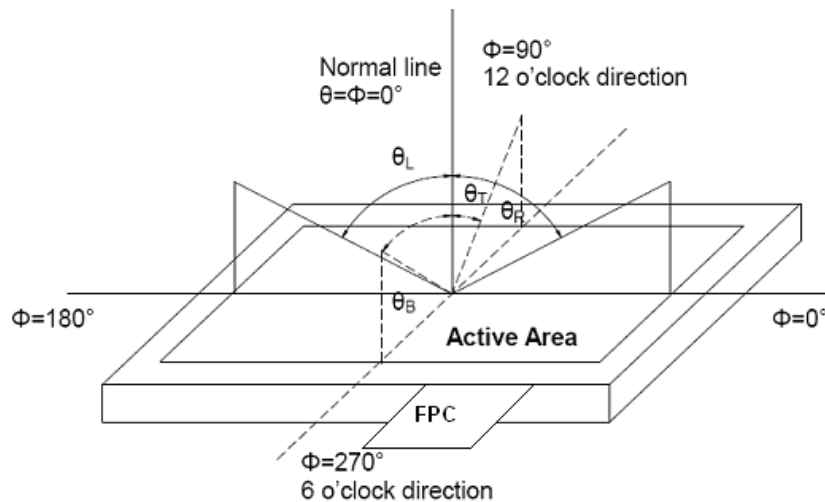

Fig2. Measurement viewing angle

Note3: Definition of contrast ratio

$$\text{Contrast ratio (CR)} = \frac{\text{Luminance measured when LCD is on the "White" state}}{\text{Luminance measured when LCD is on the "Black" state}}$$

Note4: Definition of Response time

For SFT LCM, the response time is defined as the LCD optical switching time interval between "White" state and "Black" state. Rise time (T_r) is the time between photo detector output intensity changed from 10% to 90%. And fall time (T_f) is the time between photo detector output intensity changed from 90% to 10%.

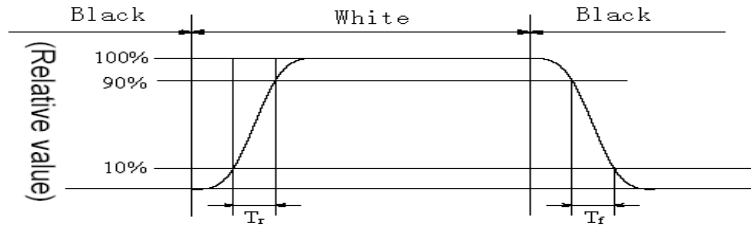

Fig4. Response Time Testing(SFT)

Note5: Definition of color chromaticity (CIE1931)

Color coordinates measured at center point of LCD.

Note6: Definition of Luminance Uniformity

Active area is divided into 9 measuring areas (Refer Fig.5). Every measuring point is placed at the center of each measuring area.

$$\text{Luminance Uniformity (U)} = L_{\min} / L_{\max}$$

L_{\max} : The measured Maximum luminance of all measurement position.

L_{\min} : The measured Minimum luminance of all measurement position.

L -----Active area length; W ----- Active area width

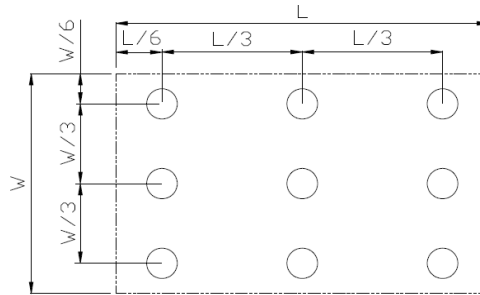

Fig5. Luminance Uniformity Measurement Locations(9 points)

Note7: Definition of Luminance:

Measure the luminance of white state at center point.

8. Reliability Test

No	Test Item	Condition	Remarks
1	High Temperature Operation	+80°C , 240H	IEC60068-2-1:2007 GB2423.2-2008
2	Low Temperature Operation	-30°C , 240H	IEC60068-2-1:2007 GB2423.1-2008
3	High Temperature Storage	+85°C , 240H	IEC60068-2-1:2007 GB2423.2-2008
4	Low Temperature Storage	-30°C , 240H	IEC60068-2-1:2007 GB2423.1-2008
5	Storage at High Temperature and Humidity(non-operation)	+60°C , 90%RH , 240H	IEC60068-2-78 :2001 GB/T2423.3—2006
6	Thermal Shock (non-operation)	-20°C , 30min~70°C , 30min , change time : 5min , 100cycle	Start with cold temperature, End with high temperature, IEC60068-2-14:1984,GB2423.22-2002
7	ESD	C=150pF , R=330Ω , 5point/panel Air : ±8kv , 5times ; Contact : ±4kv , 5times ; (Environment : 15°C~35°C , 30%~60% , 86Kpa~106Kpa)	IEC61000-4-2:2001 GB/T17626.2-2006
8	Package Vibration	5-20-200HZ , PSD : 0.01-0.01-0.001 Total:0.781g ² /HZ,x/y/z 30min)	
9	Package Drop Test	Height: X cm,1 corner, 3edges, 6 surfaces Note : X > 10Kg:60cm ; ≤10Kg:80cm	IEC60068-2-32:1990 GB/T2423.8—1995

Table 8.1 RA test condition

Note1: Temperature is the ambient temperature of sample

Note2: Before cosmetic and function test, the product must have enough recovery time, at least 2 hours at room temperature.

Note3: In the standard condition, there shall be no practical problem that may affect the display function. After the reliability test, the product's function only be guaranteed, but not for all of the cosmetic specification.

9. Mechanical Drawing

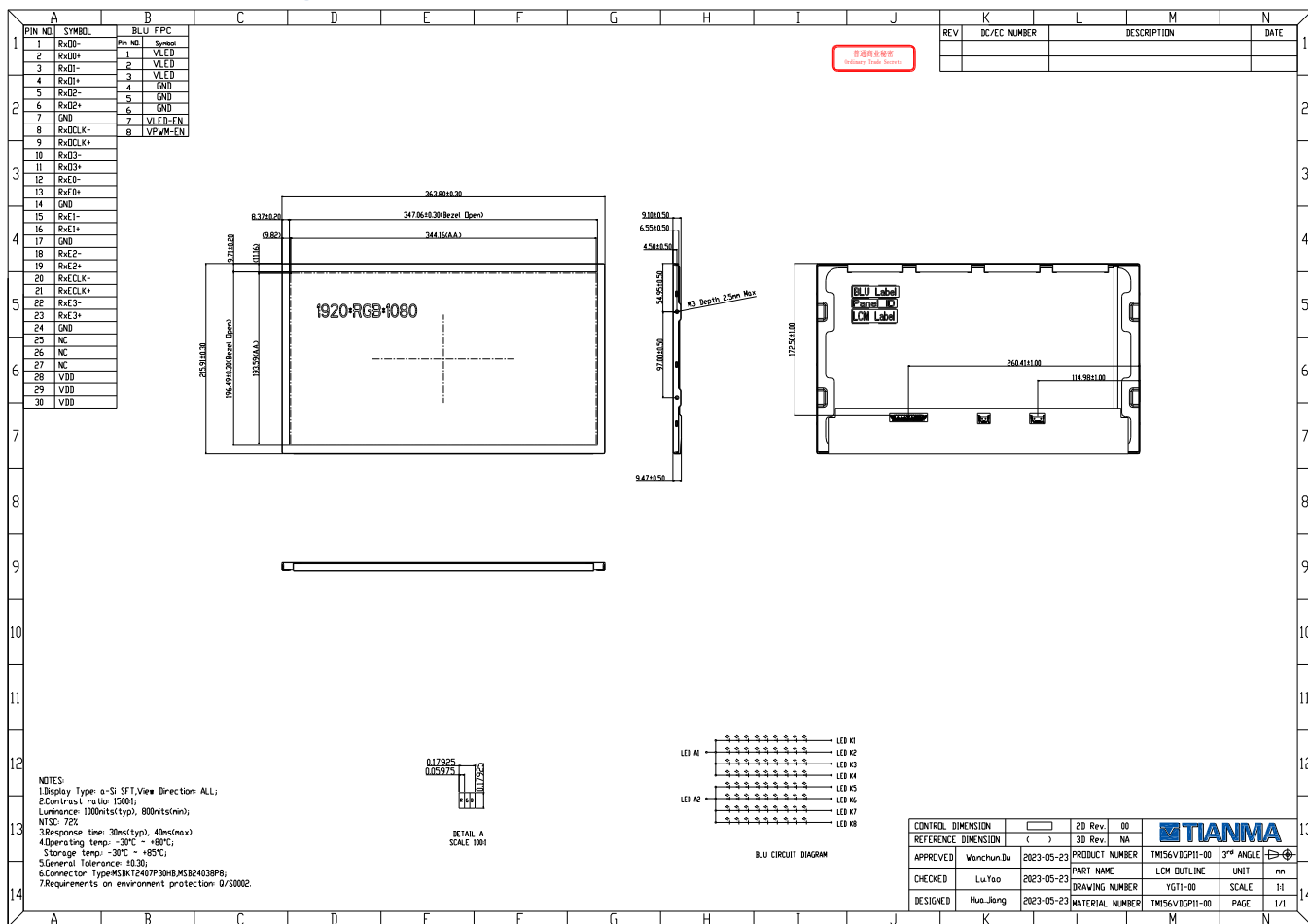

10. Packing Drawing

TBD

11. Precautions for Use of LCD Modules

11.1 Handling Precautions

- (1) The display panel is made of glass. Do not subject it to mechanical shock by dropping it, etc.
- (2) If the display panel is damaged and the liquid crystal fluid inside it leaks out be sure not to get any in your mouth. If the fluid comes into contact with your skin or clothes promptly wash it off using soap and water.
- (3) Do not apply excessive force to the display surface or the bezel since this may cause the color tone to vary.
- (4) The polarizer covering the display surface of the LCD module is soft and easily scratched. Handle the polarizer carefully.
- (5) If the display surface is contaminated, breathe on the surface and gently wipe it with a soft dry cloth. If it is still not completely clear use a moist cloth with one of the following solvents:
 - Isopropyl alcohol

- Ethyl alcohol

Solvents other than those mentioned above may damage the polarizer. Specifically, do not use the following:

- Water
- Ketone
- Aromatic solvents

- (6) Do not disassemble the LCD Module.
- (7) If powered off, do not apply the input signals.
- (8) To prevent destruction of the module by static electricity, be careful to maintain an optimum work environment.
- (9) Be sure to ground your body when handling the LCD Modules.
- (10) Tools used for assembly, must be properly grounded.
- (11) To reduce the amount of static electricity generated, do not conduct assembly or other work under very low humidity conditions.
- (12) The LCD Module is covered with a film to protect the display surface, remove film slowly under the ionizer.

11.2 Storage precautions

- (1) When storing the LCD modules avoid exposure to direct sunlight or to the light of fluorescent lamps.
- (2) The LCD modules should be stored within the rated storage temperature range. The recommend condition is: Temperature: 0 ~ 35 °C at normal humidity.
- (3) The LCD modules should be stored in a room without acid, alkali or other harmful gas.

11.3 Transportation Precautions

The LCD modules should not be dropped or subject to violent mechanical shock during transportation. Also they should avoid excessive pressure, water, high humidity and direct sunlight.

11.4 Screen saver Precautions

Not display the fixed pattern for a long time. Use a screen saver, if the fixed pattern is displayed on the screen

11.5 Safety Precautions

- (1) When you waste damaged or unnecessary LCDs, it is recommended to crush LCDs into pieces and wash them off with solvents such as acetone and ethanol, which should later be burned
- (2) Be sure to turn off the power supply when inserting or disconnecting the LED backlight cable.
- (3) LED driver should be designed to limit or stop its function when over current is detected on the LED.



ALL TECHNOLOGIES. ALL COMPETENCIES. ONE SPECIALIST.

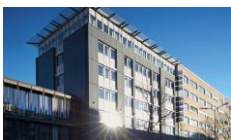

DATA MODUL AG
Landsberger Straße 322
DE-80687 Munich
Phone: +49-89-56017-0

DATA MODUL WEIKERSHEIM GMBH
Lindenstraße 8
DE-97990 Weikersheim
Phone: +49-7934-101-0

